

# COMMERCIAL VEHICLES 2020

CHEVROLET 





# STRONG TRUCKS MAKE YOUR BUSINESS EVEN STRONGER.

Strong businesses are built on strong foundations. And that starts with your trucks. Chevy is a brand you can count on to get the job done. The big news this year is the all-new Silverado HD pickup, plus an all-new Silverado 3500 HD Chassis Cab. Add this to the Silverado 1500 and medium-duty Silverado 4500 HD/5500 HD/6500 HD Chassis Cabs introduced last year, and you have a formidable lineup of trucks to help your business run on all cylinders.

**FIND NEW ROADS™**



<sup>1</sup> Terms apply. Available on select properly equipped 2015 model year and newer GM vehicles (excludes Volt, City Express Vans, Low Cab Forward Trucks and GM vehicles built without OnStar Hardware, which includes but is not limited to select base Chevrolet and GMC trucks). Requires an active connected vehicle services plan. Fees, services and availability subject to change without notice. Applicable taxes not included. Does not include emergency or security services. Diagnostic capabilities vary by vehicle model. Not all issues will deliver alerts. <sup>2</sup> 2020 GM BUSINESS CHOICE REQUIREMENTS: The 2020 GM Business Choice Program is valid from January 4, 2020, to January 3, 2021. Customer must purchase or lease a vehicle during the program period and be able to provide proof of business ownership. Vehicle must be used in the day-to-day operations of the business and not solely for transportation purposes. This program may not be compatible with other offers or incentive programs. Consult your Chevrolet dealer for program compatibility and other restrictions. For complete program requirements, including information regarding offers, vehicles, equipment, options, warranties and ordering, consult your Chevrolet dealer. <sup>3</sup> Equipment from independent suppliers is not covered by the GM New Vehicle Limited Warranty. GM is not responsible for the safety or quality of independent supplier alterations.

**OnStar Vehicle Insights!** The simple way to gain real-time insights to help your business maximize operational efficiency and optimize productivity. Get real-time vehicle information that can help you improve route planning, identify select service needs, get driver behavior data and more. Learn more at [onstarvehicleinsights.com](https://onstarvehicleinsights.com).

**Business Choice.** This program can give you the best value on the vehicles<sup>2</sup> you count on. Business Choice includes a cash allowance on either GM Accessories or Upfits<sup>3</sup> and you can even add the most current retail offers to your deal. Learn more at [chevrolet.com/business-choice-offers](https://chevrolet.com/business-choice-offers).

**Business Elite Dealers.** These specialized dealers provide the know-how to help you select the right vehicles for the job. Plus, every Business Elite service department has the facilities, tools and technicians for your needs. Learn more at [chevrolet.com/commercial/business-elite](https://chevrolet.com/commercial/business-elite).

Silverado 1500 Double Cab Standard Bed WT with available dealer-installed Bed-Mounted Tool Box from Chevrolet Accessories.



**SILVERADO 1500**

## **THE VERY DEFINITION OF WORK ETHIC.**

We put over 100 years of truck-building know-how into the next-generation Chevy Silverado. It starts with strong choices: eight models with bold styling and distinct personalities, along with six powerful, advanced engines. We added the most functional bed of any pickup and smart, purposeful technology to deliver towing confidence every day.

Truck bed offers 12 standard tie-downs with nine more available removable tie-downs from Chevrolet Accessories.

Available bed-mounted 120-volt power outlet.

Durabed combines roll-formed high-strength steel with more cargo volume than the previous generation.

## SILVERADO 1500 HIGHLIGHTS

- Six different engine choices:
  - Newly available Duramax® 3.0L Turbo-Diesel I-6 with 277 horsepower and 460 lb.-ft. of torque
  - 6.2L EcoTec3 V8 with Dynamic Fuel Management and 420 horsepower
  - 5.3L EcoTec3 V8 with Dynamic Fuel Management and 355 horsepower
  - 5.3L EcoTec3 V8 with Active Fuel Management™ and 355 horsepower
  - 4.3L EcoTec3 V6 with 285 horsepower
  - 2.7L Turbo with 310 horsepower
- Three available automatic transmissions, including a 6-, 8- or 10-speed depending on engine/model
- Fully boxed ladder-type frame made of high-strength steel
- 4-wheel antilock disc brakes with Duralife® rotors
- Available heavy-duty automatic locking rear differential
- Standard recovery hooks<sup>1</sup> (4x4 models)
- Available Z71 Off-Road Package
- Available Work Truck Package that includes skid plates and a heavy-duty air filter with air filter monitor
- Available Advanced Trailering System with in-vehicle app<sup>2</sup>



<sup>1</sup> To avoid the risk of injury, never use recovery hooks to tow a vehicle. See the Owner's Manual for more information. <sup>2</sup> App functionality and features vary with vehicle equipment and trim level. Data connection may be required. Some features require active service plan and working electrical system. Terms and limitations apply.

3500 HD Crew Cab Long Bed LT 4x4 DRW  
with available Duramax 6.6L Turbo-Diesel V8  
engine and Gooseneck/5th-Wheel Package.



## SILVERADO TOWING

# CONFIDENCE IS KEY.

Silverado 1500 and HD models offer numerous features to make towing easier, including an available Technology Package featuring cameras that offer up to 15 views<sup>1</sup> to help facilitate hitching a trailer while providing added confidence when towing. On select models, you can even choose the Bed View Camera<sup>2</sup> or Rear Camera Mirror<sup>2</sup> as individual available features. But Silverado pickups are not just about electronic towing technology. Every Silverado 3500 HD Dually equipped with the available Duramax 6.6L Turbo-Diesel engine is now capable of towing over 30,000 lbs.<sup>3, 4</sup>

<sup>1</sup> Read the vehicle Owner's Manual for important feature limitations and information. Some camera views require available accessory camera and installation. Not compatible with all trailers. See your dealer for details. <sup>2</sup> Read the vehicle Owner's Manual for important feature limitations and information. <sup>3</sup> Before you buy a vehicle or use it for trailering, carefully review the Trailering section of the Owner's Manual. The weight of passengers, cargo and options or accessories may reduce the amount you can tow. <sup>4</sup> Requires available fifth-wheel/gooseneck hitch.

Fifth-Wheel Trailer Hitch available from Chevrolet Accessories.

Trailer mirrors standard on every Silverado HD.

myChevrolet Mobile App with Trailing<sup>1</sup> syncs with the Advanced Trailing System.

Up to 15 camera views available<sup>2</sup>

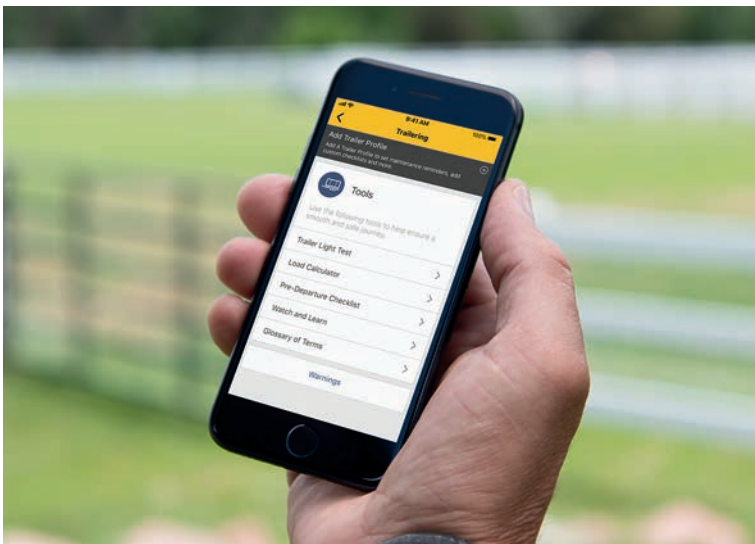

<sup>1</sup> Device data connection required. Available on select Apple and Android devices. Some features require active service plan and working electrical system. Service availability, features and functionality vary by vehicle. User terms and limitations apply. <sup>2</sup> Read the vehicle Owner's Manual for important feature limitations and information. Some camera views require available accessory camera and installation. Not compatible with all trailers. See your dealer for details.

Silverado 2500 HD Regular Cab  
Long Bed WT 4x4.



SILVERADO HD

# CAPABILITY WITHOUT COMPROMISE.

Everything we know about building trucks is found in the 2020 Chevrolet Silverado HD. It's the strongest, most capable Silverado HD ever. It has five distinct trim levels with big, bold style. Powertrain options that don't know the meaning of the word *quit*. Increased towing capability across the lineup, with advanced trailering technologies designed to make a long day of towing easy. And the hardest-working pickup bed in the business.



All-new integrated BedSteps  
and larger CornerSteps.

Snow plow installation is easier than ever. Shown  
below with upfit from an independent supplier<sup>6</sup>

Work Truck interior features a deep console for  
files along with abundant storage areas.

## SILVERADO 2500 HD AND 3500 HD HIGHLIGHTS

- All-new 6.6L V8 gas engine with Direct Injection and Variable Valve Timing, 401 horsepower and 464 lb.-ft. of torque and 6-speed transmission
- Available Duramax 6.6L Turbo-Diesel V8 with 445 horsepower and 910 lb.-ft. of torque and all-new Allison® 10-speed automatic transmission
- 35,500 lbs. of maximum towing capability<sup>1,2</sup> with available Duramax 6.6L Turbo-Diesel V8
- 17,370 lbs. of maximum towing capability<sup>2,3</sup> with 6.6L V8 gas engine
- Maximum payload of 7,442 lbs<sup>4</sup>
- 83.5 cubic feet<sup>5</sup> of cargo space on Long Bed models
- Fully boxed ladder-type frame made of high-strength steel
- Standard Durabed with a roll-formed high-strength steel floor that's stronger, lighter and more durable than a traditional stamped steel floor
- 12 standard tie-downs all rated to 500 lbs. per corner in any direction



<sup>1</sup> Requires Silverado 3500 HD Regular Cab WT 2WD DRW with available gooseneck hitch. <sup>2</sup> Before you buy a vehicle or use it for trailering, carefully review the Trailering section of the Owner's Manual. The weight of passengers, cargo and options or accessories may reduce the amount you can tow. <sup>3</sup> Requires Silverado 2500 HD Regular Cab Long Bed with 17" wheels and available gooseneck/fifth-wheel hitch. <sup>4</sup> Requires Silverado 3500 HD Regular Cab Long Bed 2WD DRW. These maximum payload ratings are intended for comparison purposes only. Before you buy a vehicle or use it to haul people or cargo, carefully review the Vehicle Loading section of the Owner's Manual and check the carrying capacity of your specific vehicle on the label on the inside of the driver door jamb. <sup>5</sup> Cargo and load capacity limited by weight and distribution. <sup>6</sup> Equipment from independent suppliers is not covered by the GM New Vehicle Limited Warranty. GM is not responsible for the safety or quality of independent supplier alterations.

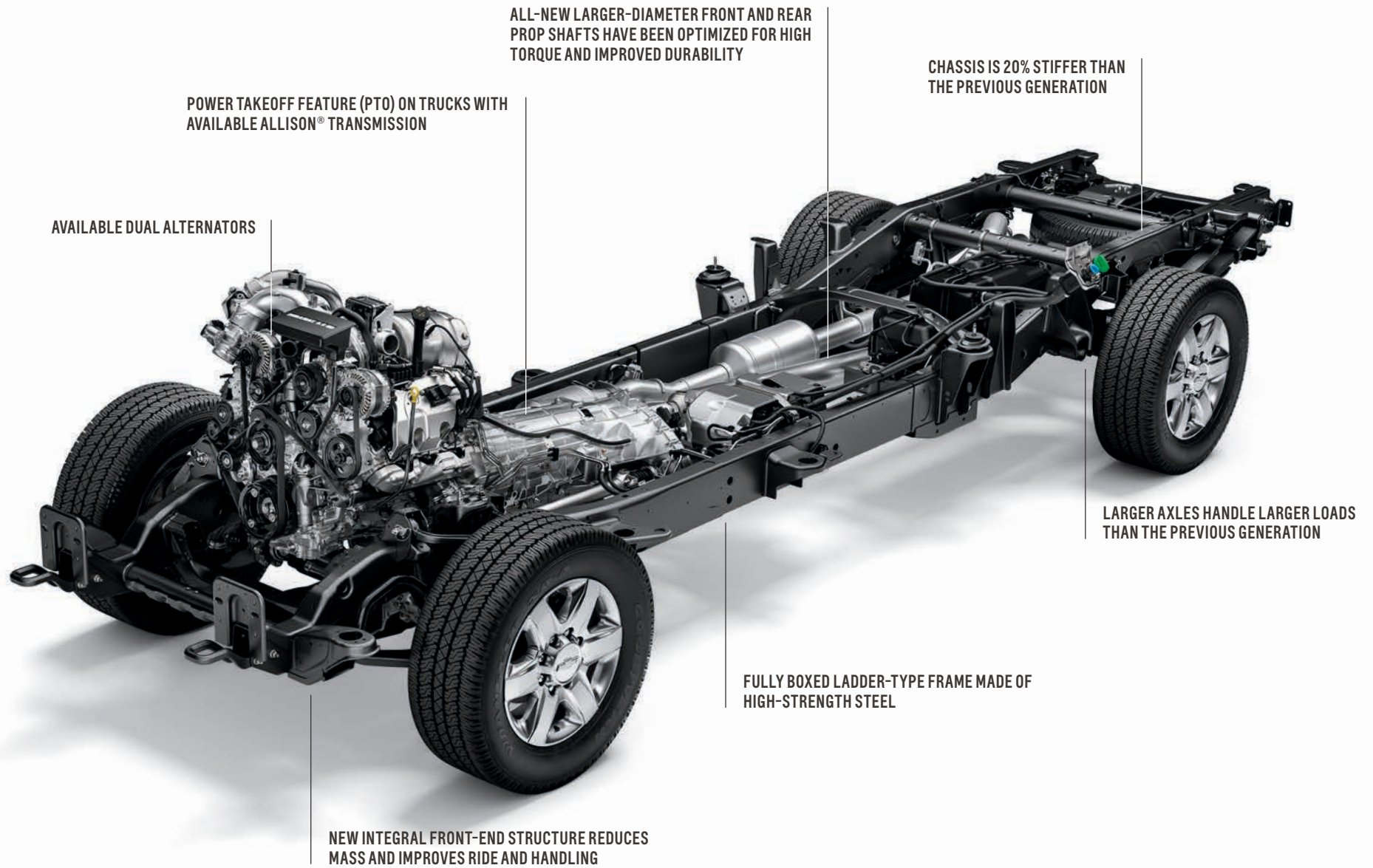

ALL-NEW LARGER-DIAMETER FRONT AND REAR PROP SHAFTS HAVE BEEN OPTIMIZED FOR HIGH TORQUE AND IMPROVED DURABILITY

CHASSIS IS 20% STIFFER THAN THE PREVIOUS GENERATION

POWER TAKEOFF FEATURE (PTO) ON TRUCKS WITH AVAILABLE ALLISON® TRANSMISSION

AVAILABLE DUAL ALTERNATORS

LARGER AXLES HANDLE LARGER LOADS THAN THE PREVIOUS GENERATION

FULLY BOXED LADDER-TYPE FRAME MADE OF HIGH-STRENGTH STEEL

NEW INTEGRAL FRONT-END STRUCTURE REDUCES MASS AND IMPROVES RIDE AND HANDLING

## CAPABILITY IS OUR MIDDLE NAME.

So bring it on. The All-New Silverado 3500 HD can handle nearly anything you throw its way. We improved or upgraded virtually every part to deliver our best heavy-duty pickup

ever. To make that happen, we used seven different types of steel, with each gauge chosen to maximize capability. That means we used the right material in the right place to help

do the right job. Everything about this truck has been optimized for durability and dependability to ensure you're driving the strongest, most capable Silverado HD ever.

Available power-up/-down tailgate lets you easily raise or lower the tailgate using the key fob.

Available LED cargo area lighting and perimeter lighting.

Durabed is the most functional truck bed of any pickup.



Silverado 3500 HD Chassis Cab with an upfit from an independent supplier.<sup>1</sup>



## SILVERADO 3500 HD CHASSIS CAB

# AN ALL-NEW CHASSIS CAB THAT'S BORN TO HAUL.

All new for 2020, the Silverado 3500 HD Chassis Cab is even stronger and more capable for any job you want to throw its way. Both Chassis Cab and Box Delete models provide a solid platform for the upfits<sup>1</sup> you need to run your business. This next-generation truck features a stiffer frame, larger axles, larger-diameter prop shafts and upgraded U-joints. There's also an abundance of power and payload capability with a choice of an all-new 6.6L V8 gas engine or a Duramax 6.6L Turbo-Diesel V8 engine, the latter equipped with an all-new Allison<sup>®</sup> 10-speed automatic transmission.

<sup>1</sup> Equipment from independent suppliers is not covered by the GM New Vehicle Limited Warranty. GM is not responsible for the safety or quality of independent supplier alterations.

Silverado 3500 HD Regular Cab Chassis Cab WT with a dump body upfit from an independent supplier!

Silverado 3500 HD Crew Cab Chassis Cab LT with a service body upfit from an independent supplier!

Interior provides plenty of storage compartments and comfort amenities.

## 3500 HD CHASSIS CAB HIGHLIGHTS

- Available Duramax 6.6L Turbo-Diesel V8 with 910 lb.-ft. of torque
- Exhaust brake standard with Duramax 6.6L engine
- All-new Allison® 10-speed automatic transmission
- All-new 6.6L V8 gas engine with 401 horsepower and 464 lb.-ft. of torque and 6-speed automatic transmission
- Available in Regular Cab or Crew Cab models, with a choice of two wheelbases for Regular Cab models
- Robust frame with high-strength steel cross members
- Larger axles with a 12" ring gear on Turbo-Diesel models
- Heavy-duty locking rear differential
- Available PTO Package
- GVWR of 14,000 lbs<sup>2</sup>
- Three fuel tank options – front, rear or combined – for an available total fuel capacity of 63.5 gallons



<sup>1</sup> Equipment from independent suppliers is not covered by the GM New Vehicle Limited Warranty. GM is not responsible for the safety or quality of independent supplier alterations. <sup>2</sup> Maximum Gross Vehicle Weight Rating (GVWR). When properly equipped; includes weight of vehicle, passengers, cargo and equipment.

Silverado 5500 HD Regular Cab with an upfit from an independent supplier.<sup>1</sup>



SILVERADO 4500 HD/5500 HD/6500 HD

## SILVERADO MEDIUM-DUTY TRUCKS. DON'T MESS WITH ANYTHING LESS.

The all-new Silverado 4500 HD, 5500 HD and 6500 HD Chassis Cabs can shoulder the heavy loads with a wide variety of chassis options to provide plenty of upfit<sup>1</sup> flexibility for your business needs. Excellent maneuverability and forward visibility, along with multiple cab-to-axle options and GVWRs, combined with advanced technology, help make the toughest work easier to tackle. Because when it comes to the job, the only word that matters is: *done*.

<sup>1</sup> Equipment from independent suppliers is not covered by the GM New Vehicle Limited Warranty. GM is not responsible for the safety or quality of independent supplier alterations.

## 4500 HD, 5500 HD AND 6500 HD CHASSIS CAB HIGHLIGHTS

- Duramax 6.6L Turbo-Diesel V8 engine optimized for medium-duty applications with 350 horsepower and 700 lb.-ft. of torque
- Allison® 6-speed close-ratio transmission with double overdrive designed for medium-duty applications
- Available exhaust brake
- GVWRs up to 23,500 lbs<sup>2</sup>
- Single-piece straight frame rails with no welds or brackets and a clean top-of-rail design to make upfitting simple and efficient
- Seven cab-to-axle options, 10 wheelbase options and five axle-to-end-of-frame options
- Three levels of available fuel capacity – a standard 40-gallon front tank, an available 25-gallon rear tank or both – provide a combined total capacity of 65 gallons
- Up to 50-degree wheel cut for impressive maneuverability
- Standard limited-slip differential
- Available rear air suspension for better ride and easier loading/unloading

Silverado 5500 HD Crew Cab with a utility upfit from an independent supplier!

Silverado 6500 HD Regular Cab with a dump truck upfit from an independent supplier!



<sup>1</sup> Equipment from independent suppliers is not covered by the GM New Vehicle Limited Warranty. GM is not responsible for the safety or quality of independent supplier alterations. <sup>2</sup> Silverado 6500 HD. Maximum Gross Vehicle Weight Rating (GVWR). When properly equipped; includes weight of vehicle, passengers, cargo and equipment.

Clamshell engine cover provides easy walk-up engine access.

There are seven different cab-to-axle options ranging from 60 to 162 inches.

The battery box is conveniently located underneath the driver door.





Silverado 6500 HD Regular Cab and  
Silverado 5500 HD Crew Cab, both with  
upfits from independent suppliers!



<sup>1</sup> Equipment from independent suppliers is not covered by the GM New Vehicle Limited Warranty. GM is not responsible for the safety or quality of independent supplier alterations.

Colorado Crew Cab WT with available features and dealer-installed Chevrolet Accessories.



COLORADO

## A GREAT UTILITY PLAYER FOR ANY FIELD YOU WORK IN.

Colorado pickup offers on-the-job capability in a smaller, more maneuverable size. It's built with hardworking truck attributes like a fully boxed high-strength steel frame with seven cross members for strength and durability. Powerful and efficient engines help Colorado turn hard jobs into routine work. Colorado also offers truck-proven technologies like Electric Power Steering, StabiliTrak® Electronic Stability Control System with rollover mitigation and Auto Grade Braking.

Available Chevrolet Infotainment System<sup>4</sup> keeps you entertained and connected while you're on the road.

Standard rear underseat storage on Extended Cab models.

Rear seatbacks on Crew Cab models fold down for extra storage space.

## COLORADO HIGHLIGHTS

- Three engines to choose from:
  - 2.5L direct injected 4-cylinder engine with 200 horsepower and 6-speed automatic transmission
  - Available 3.6L direct injected DOHC V6 engine with 308 horsepower and 275 lb.-ft. of torque and 8-speed automatic transmission
  - Available Duramax 2.8L Turbo-Diesel I-4 engine with 181 horsepower and 30 MPG highway<sup>1</sup> and 6-speed automatic transmission
- Standard CornerStep rear bumper
- Maximum payload of 1,578 lbs<sup>2,3</sup> with available 3.6L engine
- Available Z82 Trailering Package and integrated trailer brake controller
- Available automatic locking rear differential
- 4-wheel antilock disc brakes with Duralife rotors
- Four standard fixed lower tie-downs with an additional 13 available
- Available factory-installed spray-on bedliner



<sup>1</sup> EPA-estimated MPG city/highway: Colorado 2WD with available Duramax 2.8L Turbo-Diesel engine 20/30. <sup>2</sup> Requires Colorado Crew Cab Short Box WT 2WD with available 3.6L V6 engine. <sup>3</sup> These maximum payload ratings are intended for comparison purposes only. Before you buy a vehicle or use it to haul people or cargo, carefully review the Vehicle Loading section of the Owner's Manual and check the carrying capacity of your specific vehicle on the label on the inside of the driver door jamb. <sup>4</sup> Chevrolet Infotainment System functionality varies by model. Full functionality requires compatible Bluetooth and smartphone, and USB connectivity for some devices.

Express 3500 Extended Wheelbase  
Cargo Van with available features.



## EXPRESS CARGO VAN

# IT LOOKS EVEN BETTER ON YOUR BALANCE SHEETS.

For many businesses, there's no substitute for a hardworking full-size van. Express 2500 and 3500 vans give you what matters most – a choice of strong powertrains, an easily configurable cargo bay, over 280 cubic feet of cargo space<sup>1</sup> and a standard-height roof that provides easy access to parking garages and takes the worry out of backing up in unfamiliar low-clearance areas. Plus, its proven design means it can be a dependable partner to your business for many years.

<sup>1</sup> Express Cargo Van with Extended Wheelbase. Cargo and load capacity limited by weight and distribution.

Up to 10,000 lbs<sup>3</sup> of towing capability.

Numerous equipment packages for your exact needs are available from independent suppliers<sup>4</sup>

## EXPRESS CARGO VAN HIGHLIGHTS

- Standard 4.3L V6 engine with 276 horsepower and 298 lb.-ft. of torque
- Available Vortec™ 6.0L V8 engine with 341 horsepower and 373 lb.-ft. of torque
- Available Duramax 2.8L Turbo-Diesel engine with 181 horsepower and 369 lb.-ft. of torque (late availability) with standard exhaust brake
- Full-frame design for strength and durability
- Maximum payload capacity of 4,250 lbs<sup>1</sup>
- Available heavy-duty automatic locking rear differential
- Up to 10,000 lbs<sup>3</sup> of towing capability
- Up to 283.6 cubic feet of cargo space<sup>2</sup>
- Six standard D-ring cargo tie-downs
- Available interior bin packages and rooftop storage for ladders and other large work gear
- StabiliTrak Electronic Stability Control System



<sup>1</sup> Express 3500 Cargo Van with 4.3L V6 engine and 135" wheelbase. These maximum payload ratings are intended for comparison purposes only. Before you buy a vehicle or use it to haul people or cargo, carefully review the Vehicle Loading section of the Owner's Manual and check the carrying capacity of your specific vehicle on the label on the inside of the driver door jamb. <sup>2</sup> Express Cargo Van with Extended Wheelbase. Cargo and load capacity limited by weight and distribution. <sup>3</sup> With available Vortec 6.0L V8 engine. Before you buy a vehicle or use it for trailering, carefully review the Trailering section of the Owner's Manual. The weight of passengers, cargo and options or accessories may reduce the amount you can tow. <sup>4</sup> Equipment from independent suppliers is not covered by the GM New Vehicle Limited Warranty. GM is not responsible for the safety or quality of independent supplier alterations.

Available 341-horsepower Vortec 6.0L V8 engine.

Express Passenger Van is a practical choice for mobility and paratransit conversions.

Standard seating for 12 passengers and available seating for 15 with Extended Wheelbase.



## EXPRESS PASSENGER VAN HIGHLIGHTS

- Standard seating for 12 passengers
- Available seating for 15 with Extended Wheelbase
- Standard rear passenger air conditioning
- Standard 4.3L V6 engine with 276 horsepower and 298 lb.-ft. of torque
- Available Vortec 6.0L V8 engine with 341 horsepower and 373 lb.-ft. of torque
- Available Duramax 2.8L Turbo-Diesel engine with 181 horsepower and 369 lb.-ft. of torque (late availability) with standard exhaust brake
- StabiliTrak Electronic Stability Control System
- Standard 4-wheel antilock disc brakes
- Standard Rear Vision Camera<sup>1</sup>



<sup>1</sup> Read the vehicle Owner's Manual for important feature limitations and information.

Express 3500 Extended Wheelbase  
Passenger Van with available features.



## EXPRESS PASSENGER VAN

# A LARGE VAN THAT MOVES SMALL CROWDS.

Express Passenger Van is built to haul people, with a choice of 12- or 15-passenger seating, depending on model. Standard features like a StabiliTrak Electronic Stability Control System, a Tire Pressure Monitoring System<sup>1</sup> and antilock brakes let you travel with confidence. Express Passenger Van's proven design means you can count on years of dependable service. Technology features like a 120-volt power outlet, available 4G LTE Wi-Fi<sup>®</sup> Hotspot<sup>2</sup> and an available USB port<sup>3</sup> can help keep passengers entertained during trips.

Express 4500 Cutaway with an upfit from an independent supplier!



## EXPRESS CUTAWAY

# AN EXPRESS CUTAWAY FOR ANY PROFESSION.

If you need additional volume and capacity over a traditional van and still want ease and convenience for the operator, check out Express Cutaway. The full-frame design of Express Cutaway can handle a wide variety of upfits<sup>1</sup>, including service/utility, cube body or shuttle bus. Its robust construction is strong, versatile and proven. The perimeter frame provides a stable platform for a confident driving experience and many years of durability. Express Cutaway is cut out to be the right choice for whatever you have in mind.

<sup>1</sup> Equipment from independent suppliers is not covered by the GM New Vehicle Limited Warranty. GM is not responsible for the safety or quality of independent supplier alterations.



Express Cutaway 3500 models come in various box sizes from independent upfitters!

Express 4500 models feature dual rear wheels for heavier applications.

Utility truck upfits are available in multiple configurations from independent upfitters!

## EXPRESS 3500 AND 4500 CUTAWAY HIGHLIGHTS

- Standard 4.3L V6 engine with 276 horsepower and 298 lb.-ft. of torque
- Available Vortec 6.0L V8 engine with 341 horsepower and 373 lb.-ft. of torque
- Available compressed natural gas (CNG)/liquified propane gas (LPG) capable V8 engine
- Available GVWR up to 14,200 lbs<sup>2</sup>
- Full ladder-type frame design for strength and durability
- Up to three different available wheelbase lengths – 139", 159" and 177"
- Available automatic locking rear differential
- StabiliTrak Electronic Stability Control System
- Hill Start Assist
- 4-wheel antilock disc brakes



<sup>1</sup> Equipment from independent suppliers is not covered by the GM New Vehicle Limited Warranty. GM is not responsible for the safety or quality of independent supplier alterations. <sup>2</sup> Express 4500 Cutaway. Maximum Gross Vehicle Weight Rating (GVWR). When properly equipped; includes weight of vehicle, passengers, cargo and equipment.

Low Cab Forward 4500  
Regular Cab with an upfit from  
an independent supplier!

## LOW CAB FORWARD

# GETS IN AND OUT OF TIGHT SPOTS.

From construction to landscaping to wholesale delivery, Chevy Low Cab Forward trucks offer a smarter way to work, with a high level of maneuverability, low cost of ownership and remarkable reliability. The agile cab-over design makes it perfect in congested urban areas or tight jobsites where visibility and maneuverability are key. From the powerful 6500 XD to the city-friendly 3500, it's an efficient and dependable lineup offering Regular Cab and Crew Cab configurations and a wide range of engines, wheelbases and upfits!

<sup>1</sup> Equipment from independent suppliers is not covered by the GM New Vehicle Limited Warranty. GM is not responsible for the safety or quality of independent supplier alterations.

Low Cab Forward 6500 XD Regular Cab with  
an upfit from an independent supplier!

Low Cab Forward trucks come in a choice of  
wheelbases for your professional needs.

## LOW CAB FORWARD HIGHLIGHTS

- 3500 and 4500:
  - 6.0L V8 gasoline engine
  - 6-speed transmission with double overdrive
  - 297 horsepower and 372 lb.-ft. of torque
  - Available in Regular Cab and Crew Cab configurations
- 4500 HD, 4500 XD, 5500 HD, 5500 XD and 6500 XD:
  - 5.2L I-4 4H Turbo-Diesel engine with Allison® 2550 Rugged Duty Series (RDS) automatic transmission on 6500 XD models
  - 215 horsepower and 452 lb.-ft. of torque (6500 XD has 520 lb.-ft. of torque)
  - 4500 HD, 4500 XD, 5500 HD and 5500 XD available in Regular Cab and Crew Cab configurations
  - 6500 XD available in Regular Cab configuration
- Ladder-type frame with single-piece straight frame rails for strength, durability and ease of upfit<sup>1</sup>
- GVWR up to 25,950 lbs<sup>2</sup>
- Available in a range of wheelbases with body applications ranging from 10 ft. to 30 ft.
- Standard cornering lamps



<sup>1</sup> Equipment from independent suppliers is not covered by the GM New Vehicle Limited Warranty. GM is not responsible for the safety or quality of independent supplier alterations. <sup>2</sup> Low Cab Forward 6500 XD. Maximum Gross Vehicle Weight Rating (GVWR). When properly equipped; includes weight of vehicle, passengers, cargo and equipment.



POLICE/SPECIAL SERVICE

# VERSATILITY FOR ANY LAW ENFORCEMENT NEED.

All vehicles shown with  
aftermarket equipment.

Chevrolet commands authority with its formidable lineup of diverse, reliable Police Pursuit Vehicles (PPV) and Special Service Vehicles (SSV). Designed to help protect those who protect us, each vehicle offers cutting-edge safety features and impressive cargo capacity.

**Tahoe.** The rugged body-on-frame chassis and suspension system make Tahoe the ideal full-size SUV for extreme-duty conditions. And with an efficient 5.3L EcoTec3 V8 engine, Tahoe offers impressive highway fuel economy! Available as 2WD PPV, 4WD PPV and 4WD SSV models.

**Impala.** Ideal for undercover and non-pursuit police work, the Chevrolet Impala is the full-size sedan made to help take down criminal activity. Impala offers generous, well-designed cargo space as well as a spacious and comfortable interior.

**Silverado.** A proven performer built with heavy-duty specialized components, Silverado 1500 Crew Cab Special Service trucks provide impressive capability. Power comes from a fuel-efficient<sup>2</sup> 5.3L EcoTec3 V8 engine.

<sup>1</sup> EPA-estimated MPG city/highway: 15/22 (2WD), 14/20 (4WD). <sup>2</sup> EPA-estimated MPG city/highway: 16/23 (2WD), 16/22 (4x4).

## SUVS, CARS AND CROSSOVERS

# THE NATURE OF YOUR BUSINESS MIGHT REQUIRE A DIFFERENT SHAPE.

If your needs involve transporting customers or you maintain a dedicated, on-the-road sales staff, Chevrolet has a wide range of SUVs, crossovers and cars that could be just right for your business.

Tahoe and Suburban offer legendary capability with seating for up to nine passengers!

Traverse, Blazer and Equinox crossovers offer premium comfort and surprising fuel economy<sup>2</sup> while Trax is excellent for maneuvering around the city.

Malibu is a tasteful, roomy sedan while Bolt EV, Sonic and Spark offer great fuel economy<sup>3</sup> and small exterior dimensions for urban delivery and courier services.

Top: Malibu seats five in comfort and style.

Bottom: Bolt EV goes 259 miles on a single charge<sup>4</sup>



<sup>1</sup> On Fleet and LS models only with front split-bench seat. <sup>2</sup> Traverse EPA-estimated MPG city/highway with 3.6L V6 18/27 (FWD), 17/25 (AWD). Blazer EPA-estimated MPG city/highway with 2.5L 21/27; with 3.6L V6 19/26 (FWD), 18/25 (AWD); with 2.0L Turbo 21/28 (FWD), 21/27 (AWD). Equinox EPA-estimated MPG city/highway with 1.5L Turbo 26/31 (FWD), 25/30 (AWD); with 2.0L Turbo 22/29 (FWD), 22/28 (AWD). <sup>3</sup> Bolt EV EPA-estimated 118 MPGe combined city/highway. Sonic EPA-estimated MPG city/highway 26/34. Spark EPA-estimated MPG city/highway 29/38 with 5-speed manual transmission, 30/38 with available Continuously Variable Transmission (CVT); Spark ACTIV 29/37 with 5-speed manual transmission and 30/37 with available CVT. <sup>4</sup> EPA-estimated 259-mile EV range. Your actual range may vary based on several factors, including temperature, terrain, battery age and how you use and maintain your vehicle.

**Top: Tahoe and Suburban provide smooth comfort for up to nine!**

**Bottom: Traverse, Blazer, Equinox and Trax offer available all-wheel-drive capability.**



<sup>1</sup> On Fleet and LS models only with front split-bench seat.

# SILVERADO HD

## MODEL AVAILABILITY ● AVAILABLE – NOT AVAILABLE

MODEL	SERIES	STANDARD ENGINE 6.6L V8 GAS	AVAILABLE ENGINE DURAMAX 6.6L V8	2WD	4x4	REGULAR CAB LONG BED	DOUBLE CAB STANDARD BED	DOUBLE CAB LONG BED	CREW CAB STANDARD BED	CREW CAB LONG BED
WT	2500 HD	●	●	●	●	●	●	●	●	●
	3500 HD	●	●	●	●	●	–	●	● <sup>1</sup>	●
CUSTOM	2500 HD	●	–	●	●	–	●	●	●	●
LT	2500 HD	●	●	●	●	●	●	●	●	●
	3500 HD	●	●	●	●	●	–	●	● <sup>1</sup>	●
LTZ	2500 HD	●	●	●	●	–	●	●	●	●
	3500 HD	●	●	●	●	–	–	–	● <sup>1</sup>	●
HIGH COUNTRY	2500 HD	●	●	–	●	–	–	–	●	●
	3500 HD	●	●	–	●	–	–	–	● <sup>1</sup>	●

## STANDARD EQUIPMENT

MECHANICAL
Air filter – high-capacity with air filtration monitoring
Brakes – 4-wheel antilock disc with Duralife brake rotors and brake lining wear indicator
Cooling – external engine and transmission oil coolers
Differential – heavy-duty automatic locking rear
Engine – 6.6L V8 gas with Variable Valve Timing (VVT) and Direct Injection
Frame – fully boxed frame with hydroformed front section
StabiliTrak – Electronic Stability Control System with Proactive Roll Avoidance and Traction Control; includes Electronic Trailer Sway Control and Hill Start Assist
Trailer Package – trailer hitch with 2.5-inch receiver and 2-inch insert, 7-pin wiring connector and Hitch Guidance <sup>2</sup>
Transmission – 6-speed automatic
EXTERIOR
BedSteps – integrated on forward portion of bed on driver and passenger side
Bumper – rear CornerSteps
Cargo area lighting – integrated with center high-mounted stop lamp
Fuel filler – capless fueling (gas engine only)
Lamps – daytime running lamps, automatic on/off with automatic delay
Pickup bed – Durabed
Tailgate and bed rail – protection cap
Tie-downs – 12 fixed cargo tie-downs, rated at 500 lbs <sup>3</sup> per corner

EXTERIOR (CONTINUED)
Tire – carrier lock
Tire – full-size spare
INTERIOR
Airbags <sup>4</sup> – dual-stage frontal airbags for driver and front outboard passenger; seat-mounted side-impact airbags for driver and front outboard passenger; head-curtain airbags for front and rear outboard seating positions; includes front outboard Passenger Sensing System for frontal outboard passenger airbag
Air conditioning
Air vents – rear, heating/cooling (Double Cab and Crew Cab)
Assist handles – driver and front passenger, A-pillar; rear passenger, B-pillar
Connectivity – Bluetooth <sup>®</sup> phone connectivity and wireless audio streaming <sup>5</sup>
Display – outside temperature
Door locks – manual (Regular Cab); power programmable with lockout protection and manual rear door child security (Double Cab and Crew Cab)
Instrument cluster – 6-gauge with speedometer, fuel level, engine temperature, tachometer, voltage and oil pressure
Power outlet – 12-volt auxiliary, front
Rear Seat Reminder <sup>6</sup> (Double Cab and Crew Cab)
Rear Vision Camera <sup>2</sup>
Teen Driver technology
Tire Pressure Monitoring System – with Tire Fill Alert (does not apply to spare tire)
Windows – manual (Regular Cab); power with driver express-up/-down, all others express-down (Double Cab and Crew Cab)

<sup>1</sup> SRW only. <sup>2</sup> Read the vehicle Owner's Manual for important feature limitations and information. <sup>3</sup> These maximum payload ratings are intended for comparison purposes only. Before you buy a vehicle or use it to haul people or cargo, carefully review the Vehicle Loading section of the Owner's Manual and check the carrying capacity of your specific vehicle on the label on the inside of the driver door jamb. <sup>4</sup> A NOTE ON CHILD SAFETY: Always use seat belts and the correct child restraint for your child's age and size, even with airbags. Even in vehicles equipped with the Passenger Sensing System, children are safer when properly secured in a rear seat in the appropriate infant, child or booster seat. Never place a rear-facing infant restraint in the front seat of any vehicle equipped with an active frontal airbag. See your vehicle Owner's Manual and the child safety seat instructions for more safety information. <sup>5</sup> Go to my.chevrolet.com/learnAbout/bluetooth to find out which phones are compatible with the vehicle. Full Bluetooth feature functionality varies by device, model and software version. <sup>6</sup> Does not detect people or items. Always check rear seat before exiting.

## SILVERADO HD (CONTINUED)

### ENGINES



#### 6.6L V8 GAS Standard on all 2500 HD and 3500 HD models.

Variable Valve Timing (VVT) and Direct Injection

6-speed automatic transmission

401 hp @ 5200 rpm

464 lb.-ft. of torque @ 4000 rpm

Displacement: 6600 cc (403 cu. in.)

Bore and stroke: 103.25 mm x 98 mm

Compression ratio: 10.75:1

Alternator: 170 amps



#### DURAMAX 6.6L TURBO-DIESEL V8 Available on 2500 HD and 3500 HD models.

Direct Injection with high-pressure common rail

Allison® 10-speed automatic transmission

445 hp @ 2800 rpm

910 lb.-ft. of torque @ 1600 rpm

Displacement: 6619 cc (403 cu. in.)

Bore and stroke: 103 mm x 99 mm

Compression ratio: 16.0:1

Alternator: 220 amps

### DIMENSIONS

	REGULAR CAB	DOUBLE CAB	CREW CAB
Length	235.5"	240.4"-256.5"	250.0"-266.0"
Wheelbase	141.5"	149.4"-162.5"	158.9"-172.0"
Height	79.9"-80.9"	79.8"-80.9"	79.7"-80.9"
Width	81.8"-96.8"	81.9"-96.8"	81.9"-96.8"

	REGULAR CAB	DOUBLE CAB	CREW CAB
Head Room (front/rear)	43.1"/-	43.0"/39.9"	43.0"/40.1"
Leg Room (front/rear)	44.5"/-	44.5"/35.2"	44.5"/43.4"
Shoulder Room (front/rear)	66.1"/-	66.0"/64.9"	66.0"/65.3"
Hip Room (front/rear)	60.9"/-	61.2"/60.2"	61.2"/60.2"

### MAXIMUM CAPACITIES

	REGULAR CAB	DOUBLE CAB	CREW CAB
Fuel tank (approximate)	36 gallons 28 gallons (Diesel)	36 gallons 29 gallons (Standard Bed Diesel)	36 gallons

Cargo volume <sup>1</sup>	69.6 cubic feet (Standard Bed) 83.5 cubic feet (Long Bed)
---------------------------	--

<sup>1</sup> Cargo and load capacity limited by weight and distribution.



# SILVERADO HD

## PAYLOAD AND TRAILER WEIGHT RATINGS

MODEL	ENGINE	WHEEL SIZE	GVWR (LBS.) <sup>1</sup>	MAX PAYLOAD (LBS.) <sup>2</sup>	MAX CONVENTIONAL TOWING (LBS.) <sup>3</sup>	MAX 5TH-WHEEL/GOOSENECK TOWING (LBS.) <sup>3</sup>
<b>2500 HD REGULAR CAB</b>						
Long Bed 2WD	6.6L V8 gas	17"/18"	9,900	3,757	14,500	17,370
	6.6L V8 gas	17"	10,000	3,857	14,500	17,370
	6.6L V8 gas	18"/20"	10,150	3,979	14,500	17,340
	Duramax 6.6L V8	17"	10,550	3,544	14,500	18,510
	Duramax 6.6L V8	18"/20"	10,750	3,715	14,500	18,480
Long Bed 4x4	6.6L V8 gas	17"/18"	10,000	3,544	14,500	17,060
	6.6L V8 gas	17"	10,250	3,794	14,500	17,060
	6.6L V8 gas	18"/20"	10,450	3,965	14,500	17,030
	Duramax 6.6L V8	17"	10,900	3,581	14,500	18,190
Duramax 6.6L V8	18"/20"	11,025	3,715	14,500	18,160	
<b>2500 HD DOUBLE CAB</b>						
Standard Bed 2WD	6.6L V8 gas	17"/18"	10,000	3,541	14,500	17,050
	6.6L V8 gas	17"	10,050	3,591	14,500	17,050
	6.6L V8 gas	18"/20"	10,250	3,762	14,500	17,000
	Duramax 6.6L V8	17"	10,700	3,390	14,500	18,200
	Duramax 6.6L V8	18"/20"	10,900	3,561	14,500	18,170
Standard Bed 4x4	6.6L V8 gas	17"/18"	10,000	3,226	14,500	16,740
	6.6L V8 gas	17"	10,350	3,576	14,500	16,740
	6.6L V8 gas	18"/20"	10,550	3,747	14,500	16,710
	Duramax 6.6L V8	17"/18"	10,000	2,375	14,500	12,610
	Duramax 6.6L V8	17"	11,000	3,375	14,500	17,890
Duramax 6.6L V8	18"/20"	11,200	3,546	14,500	17,860	
Long Bed 2WD	6.6L V8 gas	17"/18"	10,000	3,420	14,500	16,930
	6.6L V8 gas	17"	10,200	3,620	14,500	16,930
	6.6L V8 gas	18"/20"	10,400	3,792	14,500	16,900
	Duramax 6.6L V8	17"	10,900	3,424	14,500	18,040
	Duramax 6.6L V8	18"/20"	11,100	3,595	14,500	18,010

MODEL	ENGINE	WHEEL SIZE	GVWR (LBS.) <sup>1</sup>	MAX PAYLOAD (LBS.) <sup>2</sup>	MAX CONVENTIONAL TOWING (LBS.) <sup>3</sup>	MAX 5TH-WHEEL/GOOSENECK TOWING (LBS.) <sup>3</sup>
<b>2500 HD DOUBLE CAB (CONTINUED)</b>						
Long Bed 4x4	6.6L V8 gas	17"/18"	10,000	3,133	14,500	16,650
	6.6L V8 gas	17"	10,500	3,633	14,500	16,650
	6.6L V8 gas	18"/20"	10,750	3,854	14,500	16,620
	Duramax 6.6L V8	17"/18"	10,000	2,236	14,500	11,690
	Duramax 6.6L V8	17"	11,200	3,436	14,500	17,750
	Duramax 6.6L V8	18"/20"	11,450	3,657	14,500	17,720
<b>2500 HD CREW CAB</b>						
Standard Bed 2WD	6.6L V8 gas	17"/18"	10,000	3,429	14,500	16,940
	6.6L V8 gas	17"	10,150	3,579	14,500	16,940
	6.6L V8 gas	18"/20"	10,350	3,751	14,500	16,900
	Duramax 6.6L V8	17"	10,000	2,532	14,500	13,660
	Duramax 6.6L V8	18"/20"	10,000	2,561	18,140	13,470
Standard Bed 4x4	Duramax 6.6L V8	17"	10,800	3,332	14,500	18,050
	Duramax 6.6L V8	18"/20"	11,050	3,553	18,500	18,500
	6.6L V8 gas	17"/18"	10,000	3,139	14,500	16,650
	6.6L V8 gas	17"	10,450	3,589	14,500	16,650
	6.6L V8 gas	18"/20"	10,650	3,760	14,500	16,620
Long Bed 2WD	Duramax 6.6L V8	17"	10,000	2,241	14,500	11,720
	Duramax 6.6L V8	18"/20"	10,000	2,213	17,850	11,530
	Duramax 6.6L V8	17"	11,150	3,391	14,500	17,750
	Duramax 6.6L V8	18"/20"	11,350	3,563	18,500	18,500
	6.6L V8 gas	17"/18"	10,000	3,329	14,500	16,840
Long Bed 2WD	6.6L V8 gas	17"	10,300	3,629	14,500	16,840
	6.6L V8 gas	18"/20"	10,500	3,800	14,500	16,810
	Duramax 6.6L V8	17"	10,000	2,365	14,500	12,550
	Duramax 6.6L V8	18"/20"	10,000	2,336	17,970	12,350
	Duramax 6.6L V8	17"	11,000	3,365	14,500	17,880
Duramax 6.6L V8	18"/20"	11,200	3,536	18,500	18,500	

<sup>1</sup> Maximum Gross Vehicle Weight Rating (GVWR). When properly equipped; includes weight of vehicle, passengers, cargo and equipment. <sup>2</sup> These maximum payload ratings are intended for comparison purposes only. Before you buy a vehicle or use it to haul people or cargo, carefully review the Vehicle Loading section of the Owner's Manual and check the carrying capacity of your specific vehicle on the label on the inside of the driver door jamb. <sup>3</sup> Before you buy a vehicle or use it for trailering, carefully review the Trailering section of the Owner's Manual. The weight of passengers, cargo and options or accessories may reduce the amount you can tow.

## SILVERADO HD (CONTINUED)

### PAYLOAD AND TRAILER WEIGHT RATINGS

MODEL	ENGINE	WHEEL SIZE	GVWR (LBS.) <sup>1</sup>	MAX PAYLOAD (LBS.) <sup>2</sup>	MAX CONVENTIONAL TOWING (LBS.) <sup>3</sup>	MAX 5TH-WHEEL/GOOSENECK TOWING (LBS.) <sup>3</sup>
<b>2500 HD CREW CAB (CONTINUED)</b>						
Long Bed 4x4	6.6L V8 gas	17"/18"	10,000	3,040	14,500	16,550
	6.6L V8 gas	17"	10,650	3,690	14,500	16,550
	6.6L V8 gas	18"/20"	10,850	3,862	14,500	16,520
	Duramax 6.6L V8	17"	10,000	2,076	14,500	10,620
	Duramax 6.6L V8	18"/20"	10,000	2,047	16,560	10,240
	Duramax 6.6L V8	17"	11,350	3,426	14,500	17,590
	Duramax 6.6L V8	18"/20"	11,550	3,597	18,500	18,500
<b>3500 HD REGULAR CAB</b>						
Long Bed 2WD SRW	6.6L V8 gas	18"/20"	10,750	4,481	14,500	17,200
	Duramax 6.6L V8	18"/20"	11,500	4,215	14,500	21,500
Long Bed 4x4 SRW	6.6L V8 gas	18"/20"	11,100	4,534	14,500	16,950
	Duramax 6.6L V8	18"/20"	11,800	4,217	14,500	21,500
Long Bed 2WD DRW	6.6L V8 gas	17"	14,000	7,442	16,800	16,800
	Duramax 6.6L V8	17" (5th-Wheel)	14,000	6,532	20,000	32,000
	Duramax 6.6L V8	17" (Gooseneck)	14,000	6,409	20,000	35,500 <sup>4</sup>
Long Bed 4x4 DRW	6.6L V8 gas	17"	14,000	7,145	16,800	16,710
	Duramax 6.6L V8	17"	14,000	6,196	20,000	31,760
<b>3500 HD DOUBLE CAB</b>						
Long Bed 2WD SRW	6.6L V8 gas	18"/20"	11,100	4,373	14,500	16,700
	Duramax 6.6L V8	18"/20"	11,850	4,130	14,500	21,490
Long Bed 4x4 SRW	6.6L V8 gas	18"/20"	11,400	4,391	14,500	16,500
	Duramax 6.6L V8	18"/20"	12,150	4,148	14,500	21,210
Long Bed 2WD DRW	6.6L V8 gas	17"	14,000	6,985	16,400	16,400
	Duramax 6.6L V8	17"	14,000	6,059	20,000	31,500
Long Bed 4x4 DRW	6.6L V8 gas	17"	14,000	6,703	16,390	16,270
	Duramax 6.6L V8	17"	14,000	5,777	20,000	31,340

MODEL	ENGINE	WHEEL SIZE	GVWR (LBS.) <sup>1</sup>	MAX PAYLOAD (LBS.) <sup>2</sup>	MAX CONVENTIONAL TOWING (LBS.) <sup>3</sup>	MAX 5TH-WHEEL/GOOSENECK TOWING (LBS.) <sup>3</sup>
<b>3500 HD CREW CAB</b>						
Standard Bed 2WD SRW	6.6L V8 gas	18"/20"	11,000	4,316	14,500	16,700
	Duramax 6.6L V8	18"/20"	11,750	4,135	20,000	21,500
Standard Bed 4x4 SRW	6.6L V8 gas	18"/20"	11,350	4,365	14,500	16,530
	Duramax 6.6L V8	18"/20"	12,100	4,185	20,000	21,300
Long Bed 2WD SRW	6.6L V8 gas	18"/20"	11,150	4,333	14,500	16,700
	Duramax 6.6L V8	18"/20"	11,900	4,013	20,000	21,330
Long Bed 4x4 SRW	6.6L V8 gas	18"/20"	11,500	4,398	14,500	16,410
	Duramax 6.6L V8	18"/20"	12,250	4,078	20,000	21,040
Long Bed 2WD DRW	6.6L V8 gas	17"	14,000	6,894	16,300	16,200
	Duramax 6.6L V8	17"	14,000	5,892	20,000	31,400
Long Bed 4x4 DRW	6.6L V8 gas	17"	14,000	6,610	16,300	16,180
	Duramax 6.6L V8	17"	14,000	5,607	20,000	31,180

<sup>1</sup> Maximum Gross Vehicle Weight Rating (GVWR). When properly equipped; includes weight of vehicle, passengers, cargo and equipment. <sup>2</sup> These maximum payload ratings are intended for comparison purposes only. Before you buy a vehicle or use it to haul people or cargo, carefully review the Vehicle Loading section of the Owner's Manual and check the carrying capacity of your specific vehicle on the label on the inside of the driver door jamb. <sup>3</sup> Before you buy a vehicle or use it for trailering, carefully review the Trailering section of the Owner's Manual. The weight of passengers, cargo and options or accessories may reduce the amount you can tow. <sup>4</sup> Requires WT.

# SILVERADO 1500

## MODEL AVAILABILITY ● AVAILABLE – NOT AVAILABLE

TRIM LEVEL	STANDARD ENGINE	AVAILABLE ENGINES	2WD	4x4	REGULAR CAB LONG BED	DOUBLE CAB STANDARD BED	CREW CAB SHORT BED	CREW CAB STANDARD BED
WT	4.3L EcoTec3 V6 (LV3)	2.7L Turbo (L3B), 5.3L EcoTec3 V8 (L82)	●	●	●	●	●	●
CUSTOM	4.3L EcoTec3 V6 (LV3)	2.7L Turbo (L3B), 5.3L EcoTec3 V8 (L82)	●	●	–	●	●	●
CUSTOM TRAIL BOSS	4.3L EcoTec3 V6 (LV3)	5.3L EcoTec3 V8 (L82), 6.2L EcoTec3 V8 (L87)	–	●	–	●	●	●
LT	2.7L Turbo (L3B)	5.3L EcoTec3 V8 (L84), Duramax 3.0L <sup>1</sup> (LM2)	●	●	–	●	●	●
RST	2.7L Turbo (L3B)	5.3L EcoTec3 V8 (L84), 6.2L EcoTec3 V8 (L87), Duramax 3.0L <sup>1</sup> (LM2)	●	●	–	●	●	●
LT TRAIL BOSS	5.3L EcoTec3 V8 (L84)	6.2L EcoTec3 V8 (L87)	–	●	–	–	●	●
LTZ	5.3L EcoTec3 V8 (L84)	6.2L EcoTec3 V8 (L87), Duramax 3.0L <sup>1</sup> (LM2)	●	●	–	●	●	●
HIGH COUNTRY	5.3L EcoTec3 V8 (L84)	6.2L EcoTec3 V8 (L87), Duramax 3.0L <sup>1</sup> (LM2)	●	●	–	–	●	●

## STANDARD EQUIPMENT

### MECHANICAL

**Brakes** – 4-wheel antilock disc with Duralife brake rotors and brake lining wear indicator

**Frame** – fully boxed frame with hydroformed front section

**StabiliTrak** – Electronic Stability Control System with Proactive Roll Avoidance and Traction Control; includes Electronic Trailer Sway Control and Hill Start Assist<sup>2</sup>

**Steering** – rack-and-pinion with Electric Power Steering (EPS) assist

### EXTERIOR

**Bumper** – rear CornerSteps

**Cargo area lighting** – integrated with center high-mounted stop lamp

**Fuel filler** – capless fueling

**Lamps** – daytime running lamps, automatic on/off with automatic delay

**Pickup bed** – Durabed

**Tailgate and bed rail** – protection cap

**Tie-downs** – 12 fixed cargo tie-downs, rated at 500 lbs<sup>3</sup> per corner

**Tire** – carrier lock

**Tire** – full-size spare

### INTERIOR

**Airbags<sup>4</sup>** – dual-stage frontal airbags for driver and front outboard passenger; seat-mounted side-impact airbags for driver and front outboard passenger; head-curtain airbags for front and rear outboard seating positions; includes front outboard Passenger Sensing System for frontal outboard passenger airbag

**Air conditioning** – includes rear-seat air vents on Double Cab and Crew Cab

**Air filter monitor**

**Assist handles** – driver and front passenger, A-pillar; rear passenger, B-pillar

**Connectivity** – Bluetooth<sup>®</sup> phone connectivity and wireless audio streaming<sup>5</sup> and Apple CarPlay<sup>®6</sup> and Android Auto<sup>™7</sup> compatibility

**Display** – outside temperature

**Door locks** – manual (Regular Cab); power programmable with lockout protection and manual rear door child security (Double Cab and Crew Cab)

**Instrument cluster** – 6-gauge with speedometer, fuel level, engine temperature, tachometer, voltage and oil pressure

**Media** – USB port<sup>8</sup>

**Power outlet** – 12-volt auxiliary, front

**Rear Seat Reminder<sup>9</sup>**

**Rear Vision Camera<sup>2</sup>**

**Teen Driver technology**

**Tire Pressure Monitoring System** – with Tire Fill Alert (does not apply to spare tire)

**Windows** – manual (Regular Cab); power with driver express-up/-down, all others express-down (Double Cab and Crew Cab)

<sup>1</sup> Not available on Crew Cab Standard Bed 2WD models. <sup>2</sup> Read the vehicle Owner's Manual for important feature limitations and information. <sup>3</sup> These maximum payload ratings are intended for comparison purposes only. Before you buy a vehicle or use it to haul people or cargo, carefully review the Vehicle Loading section of the Owner's Manual and check the carrying capacity of your specific vehicle on the label on the inside of the driver door jamb. <sup>4</sup> A NOTE ON CHILD SAFETY: Always use seat belts and the correct child restraint for your child's age and size, even with airbags. Even in vehicles equipped with the Passenger Sensing System, children are safer when properly secured in a rear seat in the appropriate infant, child or booster seat. Never place a rear-facing infant restraint in the front seat of any vehicle equipped with an active frontal airbag. See your vehicle Owner's Manual and the child safety seat instructions for more safety information. <sup>5</sup> Go to my.chevrolet.com/learnAbout/bluetooth to find out which phones are compatible with the vehicle. Full Bluetooth feature functionality varies by device, model and software version. <sup>6</sup> Vehicle user interface is a product of Apple and its terms and privacy statements apply. Requires compatible iPhone and data plan rates apply. <sup>7</sup> Vehicle user interface is a product of Google and its terms and privacy statements apply. Requires the Android Auto app on Google Play and an Android compatible smartphone running Android 5.0 or higher. Data plan rates apply. <sup>8</sup> Not compatible with all devices. <sup>9</sup> Does not detect people or items. Always check rear seat before exiting.

## SILVERADO 1500 (CONTINUED)

### ENGINES

2.7L TURBO (L3B)	3.0L TURBO-DIESEL I-6 (LM2)	4.3L ECOTEC3 V6 (LV3)	5.3L ECOTEC3 V8 (L82)	5.3L ECOTEC3 V8 (L84)	6.2L ECOTEC3 V8 (L87)
Active Fuel Management	Diesel Exhaust Brake System	Active Fuel Management	Active Fuel Management	Dynamic Fuel Management	Dynamic Fuel Management
310 hp @ 5600 rpm	277 hp @ 3750 rpm	285 hp @ 5300 rpm	355 hp @ 5600 rpm	355 hp @ 5600 rpm	420 hp @ 5600 rpm
348 lb.-ft. torque @ 1500 rpm	460 lb.-ft. torque @ 1500 rpm	305 lb.-ft. torque @ 3900 rpm	383 lb.-ft. torque @ 4100 rpm	383 lb.-ft. torque @ 4100 rpm	460 lb.-ft. torque @ 4100 rpm
6,800 lbs. max towing capability <sup>1,2</sup>	9,300 lbs. max towing capability <sup>1,3</sup>	7,900 lbs. max towing capability <sup>1,4</sup>	11,000 lbs. max towing capability <sup>1,5</sup>	11,600 lbs. max towing capability <sup>1,6</sup>	13,400 lbs. max towing capability <sup>1,7</sup>
20 MPG city/23 highway <sup>8</sup>	23 MPG city/33 highway <sup>9</sup>	16 MPG city/21 highway <sup>10</sup>	15 MPG city/21 highway <sup>10</sup>	17 MPG city/24 highway <sup>11</sup>	16 MPG city/20 highway <sup>12</sup>

### DIMENSIONS

	REGULAR CAB	DOUBLE CAB	CREW CAB
Length	229.5"	231.7"	231.7"-241.2"
Wheelbase	139.6"	147.5"	147.4"-157.1"
Height	75.6"	75.6"-78.5"	75.4"-78.3"
Width	81.1"	81.2"	81.2"

	REGULAR CAB	DOUBLE CAB	CREW CAB
Head Room (front/rear)	43.1"/-	43.0"/39.9"	43.0"/40.1"
Leg Room (front/rear)	44.5"/-	44.5"/35.2"	44.5"/43.4"
Shoulder Room (front/rear)	66.1"/-	66.0"/64.9"	66.0"/65.2"
Hip Room (front/rear)	60.9"/-	61.2"/60.2"	61.2"/60.2"

### MAXIMUM CAPACITIES

	REGULAR CAB	DOUBLE CAB	CREW CAB
Fuel tank (approximate)	28 gallons 22 gallons (2WD Diesel)	24 gallons 22 gallons (2WD Diesel)	24 gallons 22 gallons (2WD Diesel)

Cargo volume <sup>13</sup>	89.1 cubic feet (Long Bed) 71.7 cubic feet (Standard Bed) 62.9 cubic feet (Short Bed)
----------------------------	---

<sup>1</sup> Before you buy a vehicle or use it for trailering, carefully review the Trailering section of the Owner's Manual. The weight of passengers, cargo and options or accessories may reduce the amount you can tow. <sup>2</sup> Requires Silverado 1500 Double Cab Standard Bed 2WD, Crew Cab Short Bed 2WD or Crew Cab Standard Bed 2WD. <sup>3</sup> Requires Silverado 1500 Double Cab Standard Bed 4x4 or Crew Cab Short Bed 4x4. <sup>4</sup> Requires Silverado 1500 Regular Cab Long Bed 2WD. <sup>5</sup> Requires Silverado 1500 Crew Cab Short Bed Custom 4x4 with available Max Trailering Package. <sup>6</sup> Requires Silverado 1500 Double Cab Standard Bed 2WD with available Max Trailering Package. <sup>7</sup> Requires Silverado 1500 Double Cab Standard Bed RST 4x4 with available Max Trailering Package and 20" wheels. <sup>8</sup> EPA estimated 2WD. EPA-estimated 19 MPG city/22 highway (WT 2WD; 4x4). <sup>9</sup> EPA estimated 2WD. EPA-estimated 23 MPG city/29 highway (4x4). <sup>10</sup> EPA estimated 2WD. EPA-estimated 15 MPG city/20 highway (4x4), 14 MPG city/18 highway (Trail Boss 4x4). <sup>11</sup> EPA estimated 2WD XFE. EPA-estimated 17 MPG city/23 highway (2WD), 16 MPG city/22 highway (4x4), 16 MPG city/21 highway (Trail Boss 4x4). <sup>12</sup> EPA estimated 4x4. EPA-estimated 15 MPG city/19 highway (LT Trail Boss 4x4), 14 MPG city/18 highway (Custom Trail Boss 4x4). <sup>13</sup> Cargo and load capacity limited by weight and distribution.

# SILVERADO 1500

## PAYLOAD AND TRAILER WEIGHT RATINGS

MODEL	ENGINE	MAX PAYLOAD <sup>1</sup>	MAX CONVENTIONAL TRAILER WEIGHT <sup>2</sup>
<b>REGULAR CAB</b>			
Long Bed 2WD	4.3L V6	2,250	7,900
	5.3L V8 (L82) with 6-speed	2,180	10,000
Long Bed 4x4	4.3L V6	2,130	7,700
	5.3L V8 (L82) with 6-speed	2,070	9,800
<b>DOUBLE CAB</b>			
Standard Bed 2WD	2.7L Turbo	2,070	6,800
	4.3L V6	2,040	7,700
	5.3L V8 (L82) with 6-speed	1,970	9,700
	5.3L V8 (L84) with 8-speed	1,980	9,800
	Duramax 3.0L	1,780	7,600
Standard Bed 2WD with Max Trailering Package	5.3L V8 (L84) with 8-speed	2,190	11,600
Standard Bed 4x4	2.7L Turbo	2,050	6,600
	4.3L V6	2,020	7,500
	5.3L V8 (L82) with 6-speed	1,950	9,500
	5.3L V8 (L84) with 8-speed	1,970	9,600
	6.2L V8	1,690	9,300
	Duramax 3.0L	1,770	9,300
Standard Bed 4x4 with Max Trailering Package	5.3L V8 (L84) with 8-speed	2,180	11,400
	6.2L V8	2,090	12,100
Standard Bed RST 4x4 with Max Trailering Package and 20" Wheels	6.2L V8	2,090	13,400
Standard Bed Trail Boss 4x4	4.3L V6	1,770	7,400
	5.3L V8 (L82) with 6-speed	1,670	9,500
	5.3L V8 (L84) with 10-speed	1,680	9,400
	6.2L V8	1,780	9,300
<b>CREW CAB</b>			
Short Bed 2WD	2.7L Turbo	2,060	6,800
	4.3L V6	2,040	7,700
	5.3L V8 (L82) with 6-speed	2,060	9,700
	5.3L V8 (L84) with 8-speed	2,060	9,800
	Duramax 3.0L	1,870	7,600
Short Bed 2WD with Max Trailering Package	5.3L V8 (L84) with 8-speed	2,180	11,500

MODEL	ENGINE	MAX PAYLOAD <sup>1</sup>	MAX CONVENTIONAL TRAILER WEIGHT <sup>2</sup>
<b>CREW CAB (CONTINUED)</b>			
Standard Bed 2WD	2.7L Turbo	1,990	6,800
	4.3L V6	1,960	7,600
	5.3L V8 (L82) with 6-speed	1,990	9,600
	5.3L V8 (L84) with 8-speed	1,990	9,700
Standard Bed 2WD with Max Trailering Package	5.3L V8 (L84) with 8-speed	2,110	11,400
Short Bed 4x4	2.7L Turbo	2,050	6,600
	4.3L V6	2,020	7,500
	5.3L V8 (L82) with 6-speed	2,050	9,500
	5.3L V8 (L84) with 8-speed	2,060	9,600
	5.3L V8 (L84) with 10-speed	2,060	9,300
	6.2L V8	1,670	9,200
	Duramax 3.0L	1,870	9,300
Short Bed 4x4 with Custom Max Trailering Package	5.3L V8 (L82) with 6-speed	2,050	11,000
Short Bed 4x4 with Max Trailering Package	5.3L V8 (L84) with 8-speed	2,170	11,300
	6.2L V8	2,060	12,000
Short Bed Trail Boss 4x4	4.3L V6	1,770	7,400
	5.3L V8 (L82) with 6-speed	2,050	9,500
	5.3L V8 (L84) with 10-speed	1,770	9,400
	6.2L V8	1,780	9,300
	2.7L Turbo	2,000	6,600
Standard Bed 4x4	4.3L V6	1,970	7,400
	5.3L V8 (L82) with 6-speed	2,000	9,500
	5.3L V8 (L84) with 8-speed	2,010	9,500
	5.3L (L84) V8 with 10-speed	2,010	9,200
	6.2L V8	1,600	9,100
	Duramax 3.0L	1,850	9,200
Standard Bed 4x4 with Max Trailering Package	5.3L V8 (L84) with 8-speed	2,130	11,300
	6.2L V8	2,010	11,900
Standard Bed Trail Boss 4x4	4.3L V6	1,710	7,300
	5.3L V8 (L82) with 6-speed	1,710	9,400
	5.3L V8 (L84) with 10-speed	1,720	9,400
	6.2L V8	1,780	9,300

<sup>1</sup> These maximum payload ratings are intended for comparison purposes only. Before you buy a vehicle or use it to haul people or cargo, carefully review the Vehicle Loading section of the Owner's Manual and check the carrying capacity of your specific vehicle on the label on the inside of the driver door jamb. <sup>2</sup> Before you buy a vehicle or use it for trailering, carefully review the Trailering section of the Owner's Manual. The weight of passengers, cargo and options or accessories may reduce the amount you can tow.

# COLORADO

## MODEL AVAILABILITY ● AVAILABLE – NOT AVAILABLE

TRIM LEVEL	STANDARD ENGINE	AVAILABLE ENGINES	2WD	4x4	EXTENDED CAB LONG BOX	CREW CAB SHORT BOX	CREW CAB LONG BOX
BASE	2.5L DOHC 4-cylinder	–	●	–	●	–	–
WT	2.5L DOHC 4-cylinder	3.6L DOHC V6, Duramax 2.8L Turbo-Diesel <sup>1</sup>	●	●	●	●	●
LT	2.5L DOHC 4-cylinder	3.6L DOHC V6, Duramax 2.8L Turbo-Diesel <sup>2</sup>	●	●	●	●	●
Z71	3.6L DOHC V6	Duramax 2.8L Turbo-Diesel <sup>3</sup>	●	●	●	●	●
ZR2	3.6L DOHC V6	Duramax 2.8L Turbo-Diesel	–	●	●	●	–

## STANDARD EQUIPMENT

MECHANICAL
Brakes – 4-wheel antilock, 4-wheel disc with Duralife rotors
Frame – fully boxed
StabiliTrak – Electronic Stability Control System with Traction Control
Steering – Electric Power Steering assist
EXTERIOR
Cargo box lamp – back of cab
Daytime running lamps
Fuel filler – capless fueling
Glass – windshield shade band
Tailgate handle – Black
Tire – compact spare or full-size spare

INTERIOR
Airbags <sup>4</sup> – dual-stage frontal airbags for driver and front passenger; seat-mounted side-impact airbags for driver and front outboard passenger; head-curtain airbags for front and rear outboard seating positions; includes front outboard Passenger Sensing System for frontal passenger airbag
Door locks – power programmable with lockout protection and rear door child security
Media – two USB ports <sup>5</sup> and auxiliary input jack in front center console
Rear Vision Camera <sup>6</sup>
Seat – driver power adjuster
Steering column – manual tilt
Teen Driver technology
Theft-deterrent system – engine immobilizer
Tire Pressure Monitor – with Tire Fill Alert (does not monitor spare tire, if equipped)
Visors – driver and front passenger, vanity mirrors
Windows – power driver express-up/-down, all others express-down

## PAYLOAD AND TRAILER WEIGHT RATINGS

ENGINE	AXLE RATIO	MAX GCWR (LBS.) <sup>8</sup>	MAX TRAILER WEIGHT (LBS.) <sup>7</sup>			
			EXTENDED CAB 2WD	EXTENDED CAB 4x4	CREW CAB 2WD	CREW CAB 4x4
2.5L DOHC 4-cylinder	4.10	8,500	3,500	3,500	3,500	–
3.6L DOHC V6	3.42	12,000	3,500	3,500	3,500	3,500
3.6L DOHC V6 with Trailering Package	3.42	12,000	7,000	7,000	7,000	7,000
Duramax 2.8L Turbo-Diesel 4-cylinder	3.42	12,700	–	7,700 <sup>1</sup>	7,700	7,600

<sup>1</sup> Available on Fleet and Government orders only. <sup>2</sup> Not available on Extended Cab or Crew Cab Long Box 2WD models. <sup>3</sup> Crew Cab 4x4 only. <sup>4</sup> A NOTE ON CHILD SAFETY: Always use seat belts and the correct child restraint for your child's age and size, even with airbags. Even in vehicles equipped with the Passenger Sensing System, children are safer when properly secured in a rear seat in the appropriate infant, child or booster seat. Never place a rear-facing infant restraint in the front seat of any vehicle equipped with an active frontal airbag. See your vehicle Owner's Manual and the child safety seat instructions for more safety information. <sup>5</sup> Not compatible with all devices. <sup>6</sup> Read the vehicle Owner's Manual for important feature limitations and information. <sup>7</sup> Before you buy a vehicle or use it for trailering, carefully review the Trailering section of the Owner's Manual. The weight of passengers, cargo and options or accessories may reduce the amount you can tow. <sup>8</sup> Gross Combination Weight Rating.

## SILVERADO 3500 HD CHASSIS CAB

### MODEL AVAILABILITY ● AVAILABLE

MODEL	REGULAR CAB	CREW CAB	2WD	4x4	STANDARD ENGINE	STANDARD HP @ RPM/LB.-FT. TORQUE @ RPM	AVAILABLE ENGINE	AVAILABLE HP @ RPM/LB.-FT. TORQUE @ RPM	STANDARD SEATING (REGULAR CAB/ CREW CAB)
Silverado 3500 HD	●	●	●	●	6.6L V8 gas	401 @ 5200/464 @ 4000	Duramax 6.6L V8	445 @ 2800/910 @ 1600	3/6

### STANDARD EQUIPMENT

MECHANICAL
Air filter – high-capacity with air filtration monitoring
Alternator – 170 amps
Axle – dual rear wheel
Battery – heavy-duty, 720 cold-cranking amps
Brakes – 4-wheel antilock, 4-wheel disc with Duralife rotors and brake lining wear indicator
Cooling – external engine oil and auxiliary external transmission oil coolers
Differential – heavy-duty automatic locking rear
Fuel tank – front and rear, 63.5-gallon
StabiliTrak – Electronic Stability Control System with Proactive Roll Avoidance and Traction Control; includes Electronic Trailer Sway Control and Hill Start Assist <sup>1</sup>
Steering – recirculating ball with smart flow power steering system
Transfer case – 2-speed electronic shift with push-button controls (4x4 models)
EXTERIOR
Bumpers – front, Black
Daytime running lamps – with automatic exterior lamp control
Door handles – Black
Headlamps – halogen reflector with halogen daytime running lamps
Lamps – Smoked Amber roof marker (LED)
Mirrors – vertical trailering, manual-folding and manual-extending with lower convex mirrors
Recovery hooks <sup>2</sup> – front, frame-mounted, Black

INTERIOR
Airbags <sup>3</sup> – dual-stage frontal airbags for driver and front outboard passenger; seat-mounted side-impact airbags for driver and front outboard passenger; head-curtain airbags for front and rear outboard seating positions; includes front outboard Passenger Sensing System for frontal outboard passenger airbag
Air conditioning – single-zone
Assist handles – driver and front passenger, A-pillar; rear passenger, B-pillar
Connectivity – Bluetooth <sup>®</sup> phone connectivity and wireless audio streaming <sup>4</sup>
Compass – located in instrument cluster
Display – outside temperature
Driver Information Center – 3.5-inch diagonal monochromatic display
Entertainment – Chevrolet Infotainment 3 system <sup>5</sup> with 7-inch diagonal color touch-screen
Floor covering – rubberized-vinyl
Instrument cluster – 6-gauge cluster with speedometer, fuel level, engine temperature, tachometer, voltage and oil pressure
Media – USB port <sup>6</sup> on instrument panel
Seat – rear 60/40 folding bench (folds up), 3-passenger (includes child seat top tether anchor) (Crew Cab)
Seats – front 40/20/40 split-bench
Tire Pressure Monitoring System – with Tire Fill Alert (does not apply to spare tire)

<sup>1</sup> Read the vehicle Owner's Manual for important feature limitations and information. <sup>2</sup> To avoid the risk of injury, never use recovery hooks to tow a vehicle. See the Owner's Manual for more information. <sup>3</sup> A NOTE ON CHILD SAFETY: Always use seat belts and the correct child restraint for your child's age and size, even with airbags. Even in vehicles equipped with the Passenger Sensing System, children are safer when properly secured in a rear seat in the appropriate infant, child or booster seat. Never place a rear-facing infant restraint in the front seat of any vehicle equipped with an active frontal airbag. See your vehicle Owner's Manual and the child safety seat instructions for more safety information. <sup>4</sup> Go to [my.chevrolet.com/learnAbout/bluetooth](http://my.chevrolet.com/learnAbout/bluetooth) to find out which phones are compatible with the vehicle. Full Bluetooth feature functionality varies by device, model and software version. <sup>5</sup> Chevrolet Infotainment System functionality varies by model. Full functionality requires compatible Bluetooth and smartphone, and USB connectivity for some devices. <sup>6</sup> Not compatible with all devices.

## SILVERADO 3500 HD CHASSIS CAB (CONTINUED)

### PAYLOAD AND VEHICLE WEIGHT RATINGS

MODEL	ENGINE	AXLE RATIO	GCWR (LBS.) <sup>1</sup>	MAX PAYLOAD (LBS.) <sup>2</sup>	GVWR (LBS.) <sup>3</sup>
Silverado 3500 HD Regular Cab Chassis Cab 2WD (146" Wheelbase)	6.6L V8 gas	3.73	24,000	7,571	14,000
	Duramax 6.6L V8	3.42	40,000	6,638	14,000
Silverado 3500 HD Regular Cab Chassis Cab 2WD (171" Wheelbase)	6.6L V8 gas	3.73	24,000	7,454	14,000
	Duramax 6.6L V8	3.42	40,000	6,516	14,000
Silverado 3500 HD Crew Cab Chassis Cab 2WD (177" Wheelbase)	6.6L V8 gas	3.73	24,000	7,040	14,000
	Duramax 6.6L V8	3.42	40,000	6,078	14,000
Silverado 3500 HD Regular Cab Chassis Cab 4x4 (146" Wheelbase)	6.6L V8 gas	3.73	24,000	7,204	14,000
	Duramax 6.6L V8	3.42	40,000	6,271	14,000
Silverado 3500 HD Regular Cab Chassis Cab 4x4 (171" Wheelbase)	6.6L V8 gas	3.73	24,000	7,159	14,000
	Duramax 6.6L V8	3.42	40,000	6,221	14,000
Silverado 3500 HD Crew Cab Chassis Cab 4x4 (177" Wheelbase)	6.6L V8 gas	3.73	24,000	6,713	14,000
	Duramax 6.6L V8	3.42	40,000	5,751	14,000

<sup>1</sup> Gross Combination Weight Rating. <sup>2</sup> These maximum payload ratings are intended for comparison purposes only. Before you buy a vehicle or use it to haul people or cargo, carefully review the Vehicle Loading section of the Owner's Manual and check the carrying capacity of your specific vehicle on the label on the inside of the driver door jamb. <sup>3</sup> Maximum Gross Vehicle Weight Rating (GVWR). When properly equipped; includes weight of vehicle, passengers, cargo and equipment.



## SILVERADO 4500 HD/5500 HD/6500 HD

### MODEL AVAILABILITY ● AVAILABLE

MODEL	REGULAR CAB	CREW CAB	2WD	4x4	STANDARD ENGINE	STANDARD HP @ RPM/ LB.-FT. TORQUE @ RPM	STANDARD SEATING (REGULAR CAB/CREW CAB)
Silverado 4500 HD	●	●	●	●	Duramax 6.6L V8	350 @ 2700/700 @ 1600	3/6
Silverado 5500 HD	●	●	●	●	Duramax 6.6L V8	350 @ 2700/700 @ 1600	3/6
Silverado 6500 HD	●	●	●	●	Duramax 6.6L V8	350 @ 2700/700 @ 1600	3/6

### STANDARD EQUIPMENT

#### MECHANICAL

Batteries – heavy-duty dual, 1,100 cold-cranking amps, includes battery box mounted to left side under cab

Brakes – hydraulic, heavy-duty system with 4-channel ABS

Brake – driveline parking brake system

Emissions – 50-state certified

Engine – Duramax 6.6L Turbo-Diesel V8

Fuel tank – rear, 40-gallon, mounted between frame side rails and behind rear axle

#### EXTERIOR

Assist steps

Bumper – front, Black

Daytime running lamps – with automatic exterior lamp control

Door handles – Black

Fuel filler – capped

Glass – solar absorbing, tinted

Grille guard screen – insect protection

Headlamps – halogen projector-beam

Lamps – cargo area, cab-mounted with switch on center switch bank, Smoked Amber roof marker

Wheels – 19.5" Black-painted steel

#### INTERIOR

Airbags<sup>1</sup> – single-stage frontal airbags for driver and front outboard passenger; seat-mounted side-impact airbags for driver and front outboard passenger; head-curtain airbags for front and rear outboard seating positions (Crew Cab); single-stage frontal airbags for driver and front outboard passenger; seat-mounted side-impact airbags for driver and front outboard passenger; head-curtain airbags for front outboard seating positions; includes airbag deactivation switch for front outboard passenger airbag (Regular Cab)

Assist handles – driver and front passenger, A-pillar

Cruise control – steering wheel-mounted

Door locks – power

Seats – front 40/20/40 split-bench, 3-passenger, driver and front passenger recline with outboard head restraints and center fold-down armrest with storage

Steering column – manual tilt-wheel

<sup>1</sup> A NOTE ON CHILD SAFETY: Always use seat belts and the correct child restraint for your child's age and size, even with airbags. Even in vehicles equipped with the Passenger Sensing System, children are safer when properly secured in a rear seat in the appropriate infant, child or booster seat. Never place a rear-facing infant restraint in the front seat of any vehicle equipped with an active frontal airbag. See your vehicle Owner's Manual and the child safety seat instructions for more safety information.

## SILVERADO 4500 HD/5500 HD/6500 HD (CONTINUED)

### PAYLOAD AND VEHICLE WEIGHT RATINGS

MODEL	SERIES	AXLE RATIO	MAX GCWR (LBS.) <sup>1</sup>	MAX PAYLOAD (LBS.) <sup>2</sup> (REGULAR CAB/CREW CAB)	GVWR (LBS.) <sup>3</sup>
Silverado Chassis Cab 2WD	4500 HD	4.10	37,000	6,494/5,750	14,001
	4500 HD	4.10	37,000	7,493/6,749	15,000
	4500 HD	4.10	37,000	8,493/7,749	16,000
	4500 HD	4.10	37,000	8,993/8,249	16,500
	5500 HD	4.10	37,000	9,993/9,249	17,500
	5500 HD	4.10	37,000	10,493/9,749	18,000
	5500 HD	4.10	37,000	11,933/11,196	19,500
	6500 HD	4.10	37,000	13,940/13,196	21,500
	6500 HD	4.10	37,000	14,940/14,196	22,500
	6500 HD	4.10	37,000	15,380/14,636	22,940
Silverado Chassis Cab 4x4	4500 HD	4.30	34,000	5,830/5,186	14,001
	4500 HD	4.30	34,000	6,829/6,186	15,000
	4500 HD	4.30	34,000	7,829/7,186	16,000
	4500 HD	4.30	34,000	8,329/7,686	16,500
	5500 HD	4.30	34,000	9,329/8,686	17,500
	5500 HD	4.30	34,000	9,829/9,186	18,000
	5500 HD	4.30	34,000	11,269/10,693	19,500
	6500 HD	4.30	34,000	12,686/12,193	21,000
	6500 HD	4.30	34,000	14,276/13,693	22,500
	6500 HD	4.30	34,000	14,776/14,193	23,000

<sup>1</sup> Gross Combination Weight Rating. <sup>2</sup> These maximum payload ratings are intended for comparison purposes only. Before you buy a vehicle or use it to haul people or cargo, carefully review the Vehicle Loading section of the Owner's Manual and check the carrying capacity of your specific vehicle on the label on the inside of the driver door jamb. <sup>3</sup> Maximum Gross Vehicle Weight Rating (GVWR). When properly equipped; includes weight of vehicle, passengers, cargo and equipment.

## EXPRESS CARGO VAN

### MODEL AVAILABILITY

TRIM/SERIES	DRIVE	WHEELBASE	STANDARD ENGINE	STANDARD HP @ RPM/ LB.-FT. TORQUE @ RPM	AVAILABLE ENGINES	MAX PAYLOAD (LBS.) <sup>1</sup>	STANDARD SEATING
2500 Regular Wheelbase	RWD	135"	4.3L V6	276 @ 5200/298 @ 3900	Vortec 6.0L V8, Duramax 2.8L	3,280	2
2500 Extended Wheelbase	RWD	155"	4.3L V6	276 @ 5200/298 @ 3900	Vortec 6.0L V8, Duramax 2.8L	3,060	2
3500 Regular Wheelbase	RWD	135"	4.3L V6	276 @ 5200/298 @ 3900	Vortec 6.0L V8, Duramax 2.8L	4,250	2
3500 Extended Wheelbase	RWD	155"	4.3L V6	276 @ 5200/298 @ 3900	Vortec 6.0L V8, Duramax 2.8L	4,060	2

### STANDARD EQUIPMENT

#### MECHANICAL

Brakes – 4-wheel antilock, 4-wheel disc

Engine – 4.3L V6 with Direct Injection and Variable Valve Timing

Exhaust – aluminized stainless steel muffler and tailpipe

StabiliTrak – Electronic Stability Control System with traction assistance and vehicle stability enhancement

Suspension – front independent with coil springs and stabilizer bar; rear hypoid drive axle with multi-leaf springs

Transmission – 8-speed automatic, electronically controlled with overdrive and Tow/Haul mode

#### EXTERIOR

Bumpers – front and rear, Black-painted with step pad

Daytime running lamps

Door – swing-out passenger-side, 60/40 split

Headlamps – dual halogen composite

Mirrors – manual, Black

#### EXTERIOR (CONTINUED)

Wheels – 16" steel with gray center caps and steel spare

Wipers – front intermittent wet-arm with pulse washers

#### INTERIOR

Airbags<sup>2</sup> – frontal for driver and right-front passenger

Air conditioning – single-zone manual

Audio system – AM/FM stereo with MP3 player, seek-scan, digital clock, TheftLock, random select, auxiliary jack and two front door speakers

Console – engine cover with open storage bin and three cup holders

Defogger – side windows

Power Convenience Package – power windows and power door locks

Power outlet – 120-volt

Seats – front bucket with outboard head restraints and inboard armrests, vinyl trim

<sup>1</sup> These maximum payload ratings are intended for comparison purposes only. Before you buy a vehicle or use it to haul people or cargo, carefully review the Vehicle Loading section of the Owner's Manual and check the carrying capacity of your specific vehicle on the label on the inside of the driver door jamb. <sup>2</sup> A NOTE ON CHILD SAFETY: Always use seat belts and the correct child restraint for your child's age and size, even with airbags. Even in vehicles equipped with the Passenger Sensing System, children are safer when properly secured in a rear seat in the appropriate infant, child or booster seat. Never place a rear-facing infant restraint in the front seat of any vehicle equipped with an active frontal airbag. See your vehicle Owner's Manual and the child safety seat instructions for more safety information.

## EXPRESS CARGO VAN (CONTINUED)

### PAYLOAD AND TRAILER WEIGHT RATINGS

MODEL	ENGINE	PAYLOAD (LBS.) <sup>1</sup>	GVWR (LBS.) <sup>2</sup>	MAX TRAILER WEIGHT (LBS.) <sup>3</sup>
2500 Regular Wheelbase	4.3L V6	3,280	8,600	7,400
	6.0L V8	3,050	8,600	10,000
	Duramax 2.8L	2,850	8,600	7,000
2500 Extended Wheelbase	4.3L V6	3,060	8,600	7,100
	6.0L V8	2,820	8,600	10,000
	Duramax 2.8L	2,640	8,600	6,100
3500 Regular Wheelbase	4.3L V6	4,250	9,600	7,400
	6.0L V8	4,020	9,600	10,000
	Duramax 2.8L	3,820	9,600	6,200
3500 Extended Wheelbase	4.3L V6	4,060	9,600	7,200
	6.0L V8	3,820	9,600	10,000
	Duramax 2.8L	3,930	9,900	6,000

<sup>1</sup> These maximum payload ratings are intended for comparison purposes only. Before you buy a vehicle or use it to haul people or cargo, carefully review the Vehicle Loading section of the Owner's Manual and check the carrying capacity of your specific vehicle on the label on the inside of the driver door jamb. <sup>2</sup> Maximum Gross Vehicle Weight Rating (GVWR). When properly equipped; includes weight of vehicle, passengers, cargo and equipment. <sup>3</sup> Before you buy a vehicle or use it for trailering, carefully review the Trailering section of the Owner's Manual. The weight of passengers, cargo and options or accessories may reduce the amount you can tow.

## EXPRESS PASSENGER VAN

### MODEL AVAILABILITY

TRIM/SERIES	DRIVE	WHEELBASE	STANDARD ENGINE	STANDARD HP @ RPM/ LB.-FT. TORQUE @ RPM	AVAILABLE ENGINES	MAX PAYLOAD (LBS.) <sup>1</sup>	STANDARD SEATING
2500	RWD	135"	4.3L V6	276 @ 5200/298 @ 3900	Vortec 6.0L V8, Duramax 2.8L	2,550	12
3500 Regular Wheelbase	RWD	135"	4.3L V6	276 @ 5200/298 @ 3900	Vortec 6.0L V8, Duramax 2.8L	3,550	12
3500 Extended Wheelbase	RWD	155"	4.3L V6	276 @ 5200/298 @ 3900	Vortec 6.0L V8, Duramax 2.8L	3,210	12

### STANDARD EQUIPMENT

MECHANICAL
Brakes – 4-wheel antilock, 4-wheel disc
Engine – 4.3L V6 with Direct Injection and Variable Valve Timing
Exhaust – aluminized stainless steel muffler and tailpipe
StabiliTrak – Electronic Stability Control System with traction assistance and vehicle stability enhancement
Suspension – front independent with coil springs and stabilizer bar; rear hypoid drive axle with multi-leaf springs
Transmission – 8-speed automatic, electronically controlled with overdrive and Tow/Haul mode
EXTERIOR
Daytime running lamps
Door – swing-out passenger-side, 60/40 split
Glass – full-body window package
Headlamps – dual halogen composite
Mirrors – manual, Black
Wheels – 16" steel with gray center caps and steel spare

EXTERIOR (CONTINUED)
Wipers – front intermittent wet-arm with pulse washers
INTERIOR
Airbags <sup>2</sup> – frontal for driver and right-front passenger; seat-mounted side-impact for driver and right-front passenger; roof-rail mounted head-curtain, provides coverage for outboard seating positions for first three rows only
Air conditioning – front and rear
Audio system – AM/FM stereo with MP3 player, seek-scan, digital clock, TheftLock, random select, auxiliary jack and two front door speakers
Console – engine cover with open storage bin and three cup holders
Defogger – front and side windows
Heater – rear auxiliary
Mirror – rearview, with Rear Vision Camera <sup>3</sup> display
Power Convenience Package – power windows and power door locks
Power outlet – 120-volt
Seats – 12-passenger (2-3-3-4 seating configuration; 4-passenger seat is a 50/50 split, 2-piece configuration)

### PAYLOAD AND TRAILER WEIGHT RATINGS

MODEL	ENGINE	PAYLOAD (LBS.) <sup>1</sup>	GVWR (LBS.) <sup>4</sup>	MAX TRAILER WEIGHT (LBS.) <sup>5</sup>
2500 Regular Wheelbase	4.3L V6	2,550	8,600	6,700
	6.0L V8	2,390	8,600	9,600
	Duramax 2.8L	2,200	8,600	6,300
3500 Regular Wheelbase	4.3L V6	3,550	9,600	6,700
	6.0L V8	3,390	9,600	9,600
	Duramax 2.8L	3,200	9,600	5,700
3500 Extended Wheelbase	4.3L V6	3,210	9,600	6,300
	6.0L V8	3,050	9,600	9,200
	Duramax 2.8L	3,170	9,900	5,300

<sup>1</sup> These maximum payload ratings are intended for comparison purposes only. Before you buy a vehicle or use it to haul people or cargo, carefully review the Vehicle Loading section of the Owner's Manual and check the carrying capacity of your specific vehicle on the label on the inside of the driver door jamb. <sup>2</sup> A NOTE ON CHILD SAFETY: Always use seat belts and the correct child restraint for your child's age and size, even with airbags. Even in vehicles equipped with the Passenger Sensing System, children are safer when properly secured in a rear seat in the appropriate infant, child or booster seat. Never place a rear-facing infant restraint in the front seat of any vehicle equipped with an active frontal airbag. See your vehicle Owner's Manual and the child safety seat instructions for more safety information. <sup>3</sup> Read the vehicle Owner's Manual for important feature limitations and information. <sup>4</sup> Maximum Gross Vehicle Weight Rating (GVWR). When properly equipped; includes weight of vehicle, passengers, cargo and equipment. <sup>5</sup> Before you buy a vehicle or use it for trailering, carefully review the Trailering section of the Owner's Manual. The weight of passengers, cargo and options or accessories may reduce the amount you can tow.

## EXPRESS CUTAWAY

### MODEL AVAILABILITY

TRIM/SERIES	DRIVE	WHEELBASE	CAB-TO-AXLE LENGTH	STANDARD ENGINE	STANDARD HP @ RPM/ LB.-FT. TORQUE @ RPM	STANDARD TRANSMISSION	AVAILABLE ENGINE	MAX PAYLOAD (LBS.) <sup>1</sup>	STANDARD SEATING
Express 3500 Cutaway	RWD	139"	80"	4.3L V6	276 @ 5200/298 @ 3900	8-speed automatic	Vortec 6.0L V8	7,180	2
Express 3500 Cutaway	RWD	159"	100"	4.3L V6	276 @ 5200/298 @ 3900	8-speed automatic	Vortec 6.0L V8	7,140	2
Express 3500 Cutaway	RWD (DRW)	177"	118"	Vortec 6.0L V8	341 @ 5400/373 @ 4200	6-speed automatic, heavy-duty		7,080	2
Express 4500 Cutaway	RWD (DRW)	159"	100"	Vortec 6.0L V8	341 @ 5400/373 @ 4200	6-speed automatic, heavy-duty		8,940	2
Express 4500 Cutaway	RWD (DRW)	177"	118"	Vortec 6.0L V8	341 @ 5400/373 @ 4200	6-speed automatic, heavy-duty		8,860	2

### STANDARD EQUIPMENT

#### MECHANICAL

Alternator – 150 amps

Battery – 600 cold-cranking amps, maintenance-free with rundown protection and retained accessory power

Brakes – 4-wheel antilock, 4-wheel disc

Engine – 4.3L V6 with Direct Injection and Variable Valve Timing (3500)

Exhaust – aluminized stainless steel muffler and tailpipe

StabiliTrak – Electronic Stability Control System with traction assistance and vehicle stability enhancement

Steering – power

Suspension – front independent with coil springs and stabilizer bar; rear hypoid drive axle with multi-leaf springs

Transmission – 6- or 8-speed automatic, electronically controlled with overdrive and Tow/Haul mode; includes cruise grade braking and powertrain grade braking

#### EXTERIOR

Bumpers – front, Black-painted with step pad

Daytime running lamps

Grille – Black composite

#### EXTERIOR (CONTINUED)

Headlamps – dual halogen composite

Mirrors – manual, Black

Tires – LT245/75R16E all-season, blackwall (3500)

Wheels – 16" 8-lug heavy-duty

Wipers – front intermittent wet-arm with pulse washers

#### INTERIOR

Airbags<sup>2</sup> – frontal for driver and right-front passenger

Air conditioning – single-zone manual

Audio system – AM/FM stereo with MP3 player, seek-scan, digital clock, TheftLock, random select, auxiliary jack and two front door speakers

Console – engine cover with open storage bin and three cup holders

Defogger – side windows

Power outlet – 120-volt

Seats – front bucket with outboard head restraints and inboard armrests, vinyl trim

### PAYLOAD AND VEHICLE WEIGHT RATINGS

MODEL	ENGINE	PAYLOAD (LBS.) <sup>1</sup>	GVWR (LBS.) <sup>3</sup>
Express 3500 Cutaway 139" Wheelbase	4.3L V6	5,540	10,100
	6.0L V8	7,180	12,300
Express 3500 Cutaway 159" Wheelbase	4.3L V6	5,490	10,100
	6.0L V8	7,140	12,300
Express 3500 Cutaway 177" Wheelbase	6.0L V8	7,080	12,300
Express 4500 Cutaway 159" Wheelbase	6.0L V8	8,940	14,200
Express 4500 Cutaway 177" Wheelbase	6.0L V8	8,860	14,200

<sup>1</sup> These maximum payload ratings are intended for comparison purposes only. Before you buy a vehicle or use it to haul people or cargo, carefully review the Vehicle Loading section of the Owner's Manual and check the carrying capacity of your specific vehicle on the label on the inside of the driver door jamb. <sup>2</sup> A NOTE ON CHILD SAFETY: Always use seat belts and the correct child restraint for your child's age and size, even with airbags. Even in vehicles equipped with the Passenger Sensing System, children are safer when properly secured in a rear seat in the appropriate infant, child or booster seat. Never place a rear-facing infant restraint in the front seat of any vehicle equipped with an active frontal airbag. See your vehicle Owner's Manual and the child safety seat instructions for more safety information. <sup>3</sup> Maximum Gross Vehicle Weight Rating (GVWR). When properly equipped; includes weight of vehicle, passengers, cargo and equipment.

## LOW CAB FORWARD

### MODEL AVAILABILITY ● AVAILABLE – NOT AVAILABLE

MODEL	REGULAR CAB	CREW CAB	WHEELBASE (IN.)	STANDARD ENGINE	STANDARD HP @ RPM/ LB.-FT. TORQUE @ RPM	GVWR (LBS.) <sup>1</sup>	PAYLOAD RANGE (LBS.) <sup>2</sup>	OVERALL LENGTH (IN.)
3500	●	●	109-176	6.0L V8	297 @ 4300/372 @ 4000	12,000	6,246-6,978	200.5-267.5
4500	●	●	109-176	6.0L V8	297 @ 4300/372 @ 4000	14,500	8,442-9,174	200.5-267.5
4500 HD	●	●	109-176	5.2L I-4 Diesel	215 @ 2500/452 @ 1850	14,500	7,766-8,536	200.5-267.5
4500 XD	●	●	109-176	5.2L I-4 Diesel	215 @ 2500/452 @ 1850	16,000	8,840-9,607	200.5-267.5
5500 HD	●	●	109-200	5.2L I-4 Diesel	215 @ 2500/452 @ 1850	17,950	10,680-11,461	200.5-291.5
5500 XD	●	●	109-212	5.2L I-4 Diesel	215 @ 2500/452 @ 1850	19,500	12,181-12,875	200.5-303.5
6500 XD	●	–	152-248	5.2L I-4 Diesel	215 @ 2500/520 @ 1650	25,950	14,641-15,690	274.4-418.5

### DIMENSIONS

#### REGULAR CAB

MODEL	OVERALL WIDTH (IN.)	OVERALL HEIGHT (IN.)	AXLE WIDTH (IN.)	CAB TO AXLE (IN.)	CAB TO END OF FRAME (IN.)	WHEELBASE (IN.)	OVERALL LENGTH (IN.)
3500	81.3	90.0	65.6	86.5-153.5	129.6-196.6	109-176	200.5-267.5
4500	81.3	91.1	65.6	86.5-153.5	129.6-196.6	109-176	200.5-267.5
4500 HD	81.3	90.8	65.6	86.5-153.5	129.6-196.6	109-176	200.5-267.5
4500 XD	81.3	92.4	65.6	86.5-153.5	129.6-196.6	109-176	200.5-267.5
5500 HD	81.3	92.4	65.6	86.5-177.5	129.6-220.6	109-200	200.5-291.5
5500 XD	81.3	92.4	65.6	86.5-189.5	129.6-232.6	109-212	200.5-303.5
6500 XD	93.5	112.0	72.2	127.0-223.0	192.9-337.0	152-248	274.4-418.5

#### CREW CAB

MODEL	OVERALL WIDTH (IN.)	OVERALL HEIGHT (IN.)	AXLE WIDTH (IN.)	CAB TO AXLE (IN.)	CAB TO END OF FRAME (IN.)	WHEELBASE (IN.)	OVERALL LENGTH (IN.)
3500	81.3	90.0	65.6	88.5-114.5	131.6-157.6	150-176	241.5-267.5
4500	81.3	91.1	65.6	88.5-114.5	131.6-157.6	150-176	241.5-267.5
4500 HD	81.3	90.8	65.6	88.5-114.5	131.6-157.6	150-176	241.5-267.5
4500 XD	81.3	92.4	65.6	88.5-114.5	131.6-157.6	150-176	241.5-267.5
5500 HD	81.3	92.4	65.6	88.5-114.5	131.6-157.6	150-176	241.5-267.5
5500 XD	81.3	92.4	65.6	88.5-114.5	131.6-157.6	150-176	241.5-267.5

<sup>1</sup> Maximum Gross Vehicle Weight Rating (GVWR). When properly equipped; includes weight of vehicle, passengers, cargo and equipment. <sup>2</sup> These maximum payload ratings are intended for comparison purposes only. Before you buy a vehicle or use it to haul people or cargo, carefully review the Vehicle Loading section of the Owner's Manual and check the carrying capacity of your specific vehicle on the label on the inside of the driver door jamb.

# COMMERCIAL VEHICLE DIMENSIONS

## COLORADO

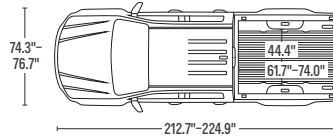
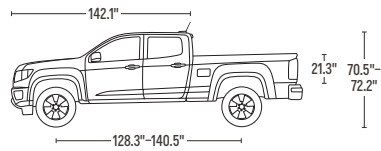
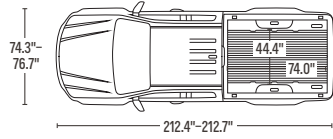
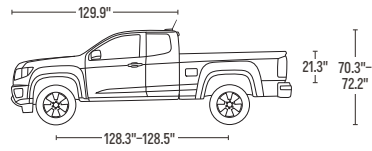

## SILVERADO 1500

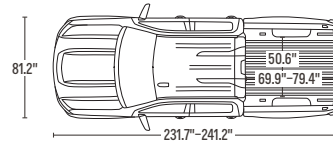
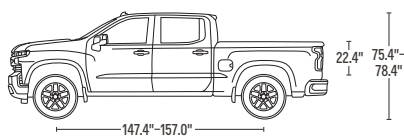
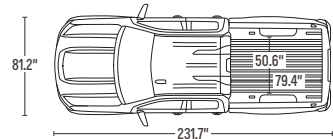
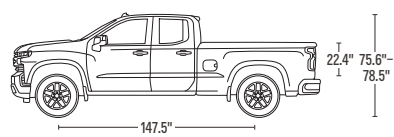
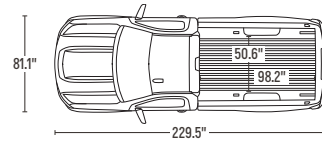
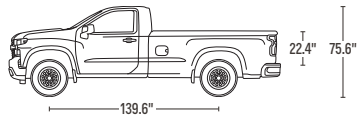

## SILVERADO 2500 HD

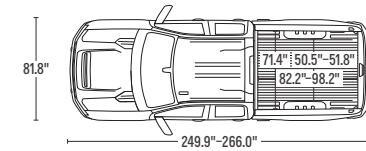
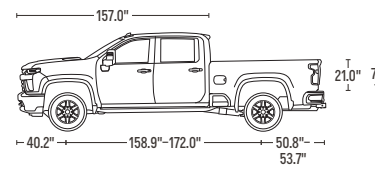
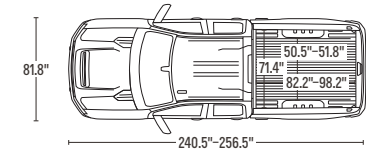
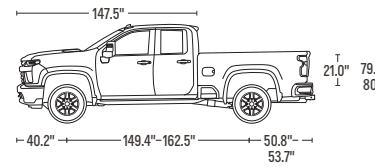
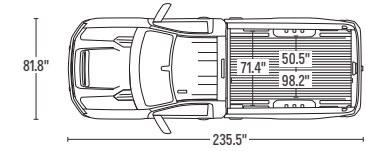
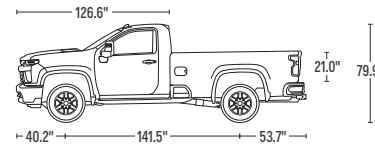

## SILVERADO 3500 HD

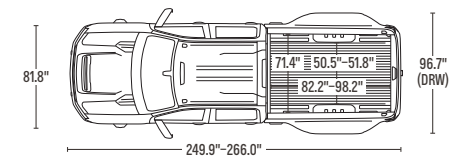
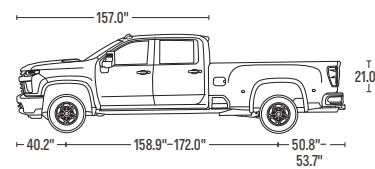

NOTE: For a complete list of all Commercial Vehicle dimensions and specifications, go to [chevrolet.com](http://chevrolet.com).



## COMMERCIAL VEHICLE DIMENSIONS (CONTINUED)

### SILVERADO 3500 HD REGULAR CAB CHASSIS CAB

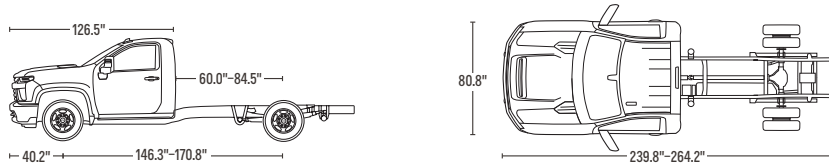

### SILVERADO 4500 HD/5500 HD/6500 HD CHASSIS CAB

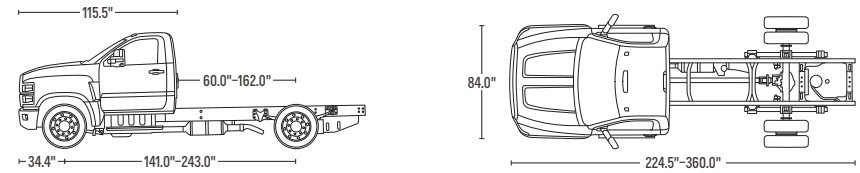

### SILVERADO 3500 HD CREW CAB CHASSIS CAB

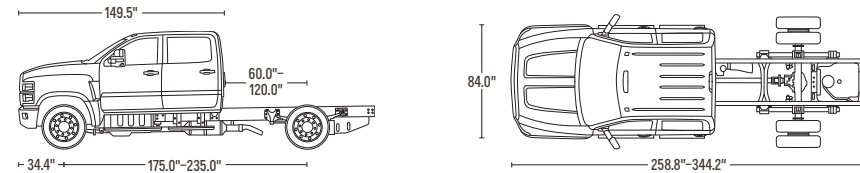
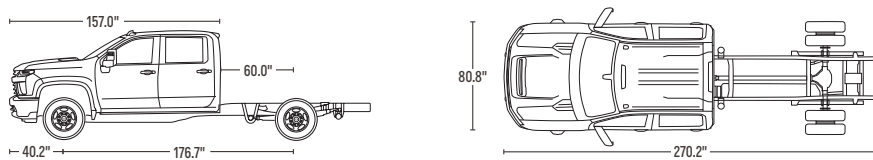

### LOW CAB FORWARD (LCF) REGULAR CAB/CREW CAB 109" Wheelbase/212" Wheelbase

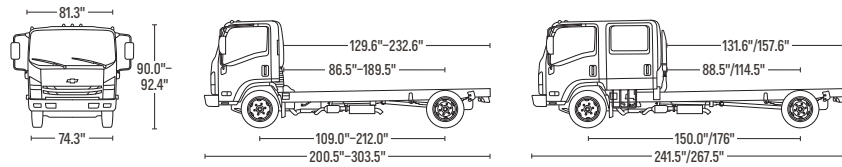

### EXPRESS PASSENGER VAN 135" Wheelbase/155" Wheelbase

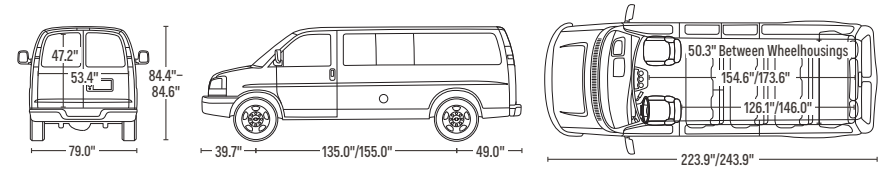

### LOW CAB FORWARD (LCF) 6500 XD 152" Wheelbase-248" Wheelbase

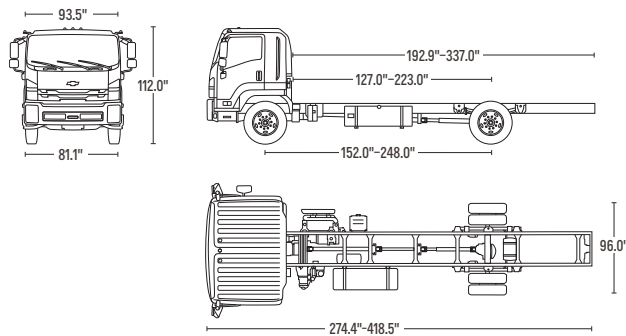

### EXPRESS CARGO VAN 135" Wheelbase/155" Wheelbase

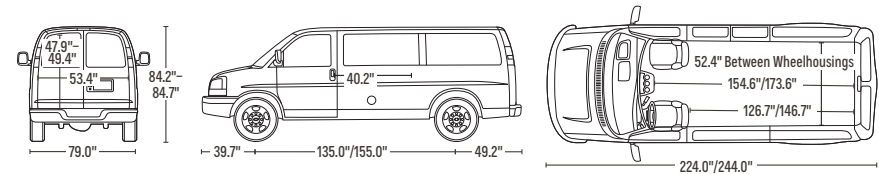

### EXPRESS CUTAWAY 139" Wheelbase/159" Wheelbase/177" Wheelbase

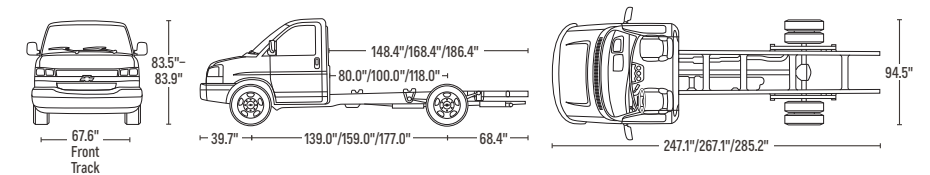

NOTE: For a complete list of all Commercial Vehicle dimensions and specifications, go to [chevrolet.com](http://chevrolet.com).

## WARRANTY

**5-year/60,000-mile transferable Powertrain Limited Warranty.** Qualifying 2020 Chevrolet Commercial vehicles come with a 5-year/60,000-mile (whichever comes first) transferable Powertrain Limited Warranty. Plus, you get 5 years/60,000 miles (whichever comes first) of the 24/7 Roadside Assistance Program, the Courtesy Transportation Program, and much more. Silverado models equipped with the available Duramax 6.6L Turbo-Diesel V8 engine, Low Cab Forward with gas engine, and qualifying fleet vehicles come with a 5-year/100,000-mile Powertrain Limited Warranty and 24/7 Roadside Assistance and Courtesy Transportation Programs. Low Cab Forward with diesel engine comes

with a 3-year/unlimited-mile Powertrain Limited Warranty and 24/7 Roadside Assistance and Courtesy Transportation Programs. See dealer for details.

**New Vehicle Limited Warranty.** GM vehicles registered in the USA are covered for 3 years/36,000 miles (whichever comes first). The complete vehicle is covered, including tires, towing to your nearest Chevrolet dealership and cosmetic corrosion resulting from defects. Repairs will be made to correct any vehicle defect, and most warranty repairs will be made at no charge. In addition, rust-through corrosion will be covered for 6 years/100,000 miles (whichever comes first). See dealer for details.

## IMPORTANT INFORMATION

**Chevrolet Owner Center (my.chevrolet.com).** Everything you need to know. Anything you need to do. Your Chevrolet Owner Center makes it easy. Create your account today to get the most out of your new vehicle. Get special alerts and offers, schedule service, review your maintenance schedule, and view how-to videos specifically for your vehicle. All online, anytime. Visit the Owner Center today to register or take a tour.

**Powertrain.** Chevrolet products are equipped with engines and/or propulsion systems produced by GM Global Propulsion Systems or other suppliers to GM worldwide. The powertrain components in Chevrolet products may also be used in other GM makes and models.

**Assembly.** Chevrolet vehicles and their components are assembled or produced by different operating units of General Motors, its subsidiaries or suppliers to GM worldwide. We sometimes find it necessary to produce Chevrolet vehicles with different or differently sourced components than originally scheduled. Since some options may be unavailable when your vehicle is assembled, we suggest you verify that your vehicle includes the equipment you ordered and that, if there were changes, they are acceptable to you.

**Chevrolet Connected Services and OnStar.** Connected vehicle services vary by vehicle model and require an active service plan, working vehicle electrical system (including battery), cell reception and GPS signal to function properly. Visit onstar.com for details and limitations.

**A note on child safety.** Always use seat belts and the correct child restraint for your child's age and size, even with airbags. Even in vehicles equipped with the Passenger Sensing System, children are safer when properly secured in a rear seat in the appropriate infant, child or booster seat. Never place a rear-facing infant restraint in the front seat of any vehicle equipped with an active frontal airbag. See your vehicle Owner's Manual and the child safety seat instructions for more safety information.



**BUSINESS  
ELITE**

**BUSINESS CHOICE OFFERS**  
FLEXIBLE SOLUTIONS FOR YOUR BUSINESS

**Business Choice/Business Elite.** You can get the commercial vehicles you depend on every day, equipped with the upfits you need to get the job done. If you are a qualified commercial customer<sup>1</sup> and purchase or lease an eligible Chevrolet van or truck, you have a choice of valuable upfit equipment or card options to meet your business needs. Small business customers can also purchase the available 5-year/100,000-mile warranty for

non-fleet purchases through the Business Choice Program. Visit gmbusinesschoice.com for details. Visit chevrolet.com for special offers and to find a Chevrolet dealer.

**Important words about this catalog.** We have tried to make this catalog comprehensive and factual. We reserve the right, however, to make changes at any time, without notice, in prices, colors, materials, equipment, specifications, models and availability. Specifications, dimensions, measurements, ratings and other numbers in this catalog and other printed materials provided at the dealership or affixed to vehicles are approximations based on design and engineering drawings, prototypes and laboratory tests. Your vehicle may differ due to variations in manufacture and equipment. Since some information may have been updated since the time of printing, please check with your Chevrolet dealer for complete details. Chevrolet reserves the right to lengthen or shorten the model year for any product for any reason or to start and end model years at different times. Certain vehicle features may lose their usefulness over time due to obsolescence from technological changes. Unless otherwise noted, all claims based on GM segmentation and latest available competitive information. Excludes other GM vehicles.

**Spare tire information.** There is no standard jack or spare tire in Express Cutaway models. Your vehicle has a tire sealant and compressor kit that uses a liquid tire sealant to temporarily seal up to a one-quarter-inch puncture in the tread area of the tire. After using the tire inflator kit, it is recommended that you take the tire to an authorized retailer for inspection and repair as soon as possible, but at least within 100 miles of driving. The tire sealant cannot seal and inflate sidewall damage, punctures larger than one-quarter inch, or a tire that has unseated from the wheel. The sealant can only be used on one tire and for one time before its expiration date.

**GMmobility.com (1-800-323-9935).** GM Mobility<sup>SM</sup> offers financial assistance for eligible adaptive equipment to make automotive travel easier for persons with disabilities or special transportation needs. To learn more about special GM Mobility offers, visit gmmobility.com.

**Trailer and off-road driving information.** Please go to chevrolet.com and carefully review an Owner's Manual for important safety information about trailering or off-road driving in your vehicle.

<sup>1</sup>To qualify for the GM Business Choice Program, your vehicle must be used in the day-to-day operations of your business and not solely for transportation purposes, and you must provide proof of your business. See your dealer for complete program details.

## WE'VE GOT YOUR BACK

At Chevrolet, giving you a completely satisfying ownership experience is our top priority. That's why if you ever need assistance, feel free to contact us at these websites or phone numbers.

**GMupfitter.com.** Offering nearly everything you need to begin upfitting your Chevy Commercial vehicle, including handling 2-D and 3-D math data; taking hotline questions; and supplying Body Builders Manuals (from 1999 to present), Technical Bulletins and Best Practices Guidelines.

**24-Hour Roadside Assistance Program (1-800-CHEV-USA).** The Chevrolet Roadside Assistance Program provides you with the following services for 5 years or 60,000 miles (whichever comes first): Emergency Towing (to closest Chevrolet dealer from a legal roadway), Lockout Service (keys locked inside vehicle), Flat Tire Changes (spare installed), Fuel Delivery (\$5 worth of fuel delivered on the road) and Jump Starts (at home or on the road). For specific terms and conditions, please contact your Chevrolet Roadside Assistance advisor at 1-800-243-8872. Some services may incur costs.

**Courtesy Transportation Program.** Ask your Chevrolet dealer for Courtesy Transportation if you leave your vehicle for extended repairs under the New Vehicle Limited Warranty or Powertrain Limited Warranty. Ask if you qualify for expense reimbursement and/or vehicle rental. Services vary by dealer. Does not apply to Express Cutaway models.

**Chevrolet Customer Assistance Center (1-800-222-1020).** Talk directly to customer relationship managers who can handle any inquiries related to vehicle operation, warranty coverages, or product or service concerns you may have. Please refer to your Owner's Manual for Customer Assistance information.

**Chevrolet.com/safety.** Chevrolet is committed to keeping you and your family safe – from the start of your journey to your destination. That's why every Chevrolet is designed with a comprehensive list of safety and security features to help give you peace of mind.

**Marketing and incentives.** Visit chevrolet.com/specialoffers or call 1-800-950-CHEV (1-800-950-2438) for new product, current incentive and marketing program information.

**The BuyPower Card.** The Chevrolet BuyPower Card – Every purchase you make with the BuyPower Card from Capital One\* helps you earn toward an eligible new Chevrolet, Buick, GMC or Cadillac vehicle. There's no limit on the amount you can earn or redeem, and your Earnings don't expire. Visit chevroletbuypowercard.com/catalogs.

\* Capital One, N.A. is the issuer of the BuyPower Card. General Motors ("GM") is responsible for the operation and administration of the Earnings program.

GM, the GM logo, Chevrolet, the Chevrolet logo and the slogans, emblems, vehicle model names, vehicle body designs and other marks appearing in this catalog are the trademarks and/or service marks of General Motors, its subsidiaries, affiliates or licensors. Allison is a registered trademark of Allison Transmission, Inc. ©2019 OnStar. All rights reserved. ©2019 General Motors. All rights reserved. December 2019

## FIND NEW ROADS™